

ASCOLI COLLECTION

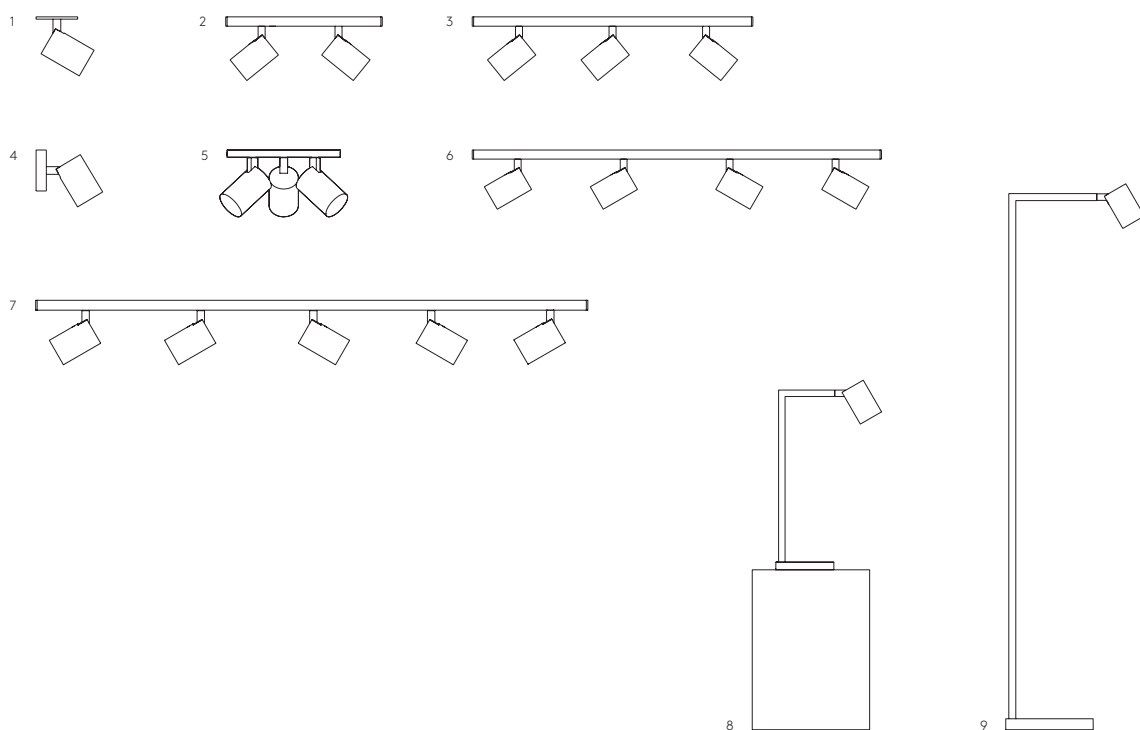

- | | | | |
|--------------------|--------|-------------|--------|
| 1. RECESSED | P. 537 | 6. FOUR BAR | P. 537 |
| 2. TWIN | P. 537 | 7. FIVE BAR | P. 537 |
| 3. TRIPLE BAR | P. 537 | 8. DESK | P. 409 |
| 4. SINGLE/SWITCHED | P. 537 | 9. FLOOR | P. 411 |
| 5. TRIPLE ROUND | P. 537 | | |



ENNA COLLECTION

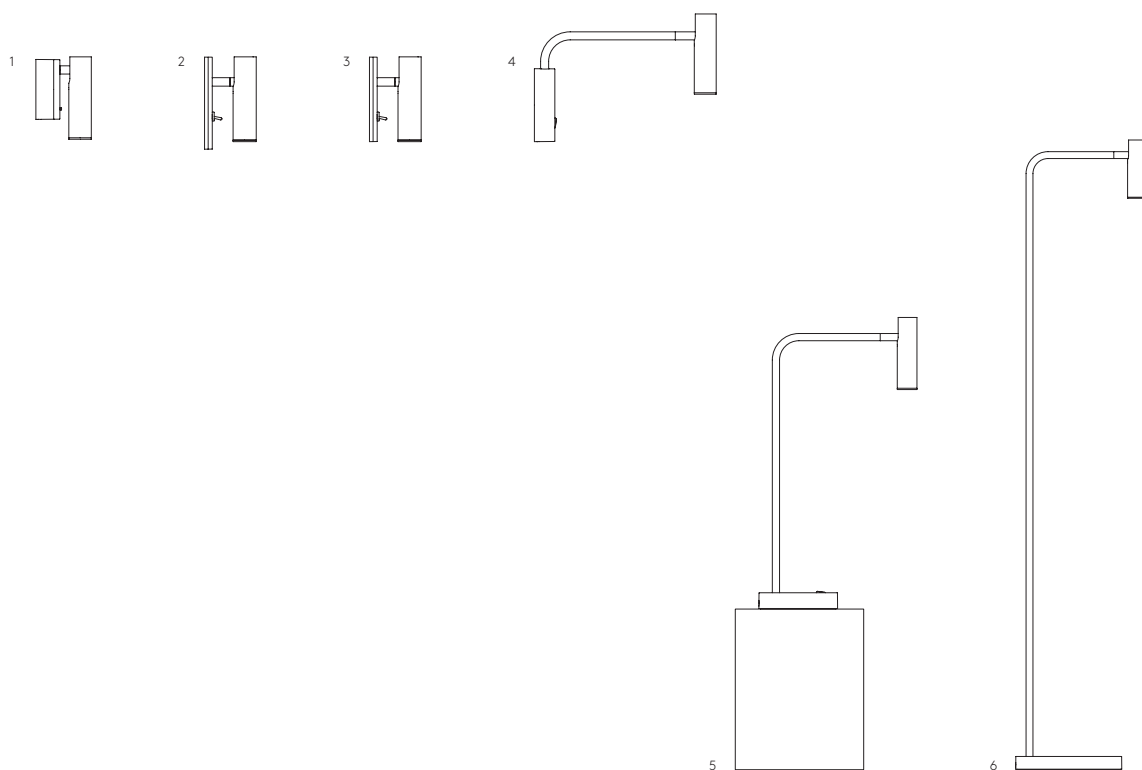

- | | | | |
|--------------------|--------|----------|--------|
| 1. SURFACE | P. 313 | 4. WALL | P. 309 |
| 2. RECESS SWITCHED | P. 315 | 5. DESK | P. 413 |
| 3. SQUARE SWITCHED | P. 311 | 6. FLOOR | P. 415 |



ATELIER COLLECTION

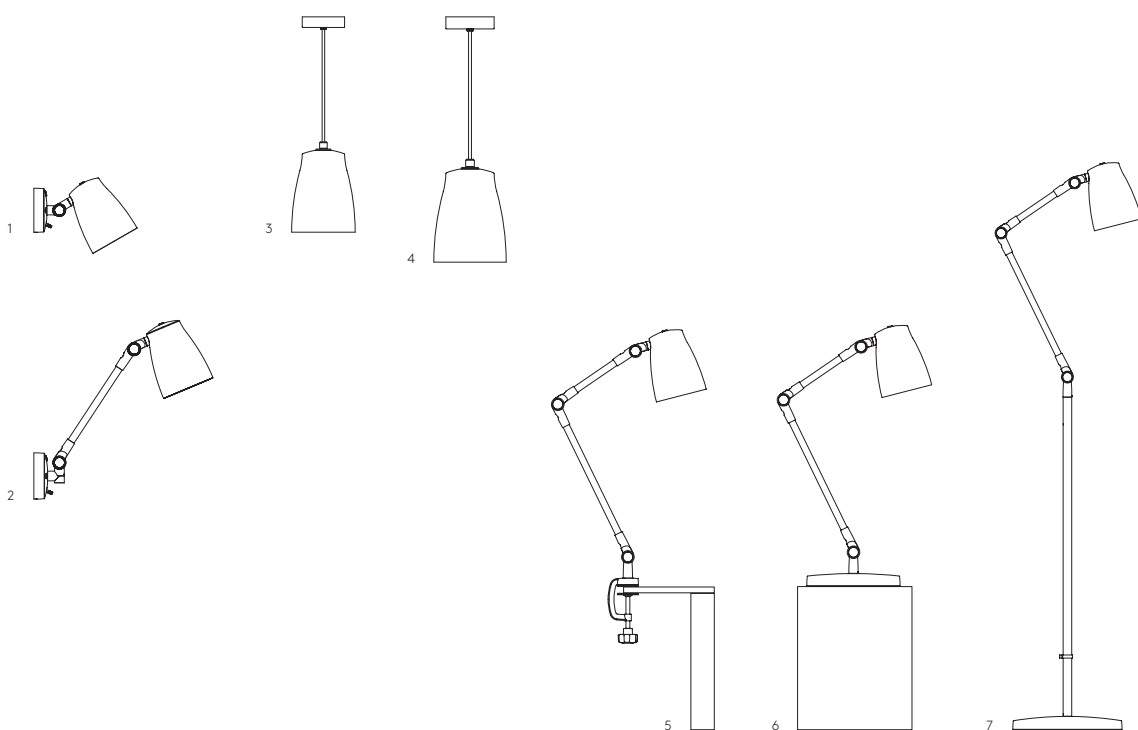

- | | | | |
|----------------|--------|----------|--------|
| 1. WALL | P. 283 | 5. CLAMP | P. 417 |
| 2. GRANDE WALL | P. 285 | 6. DESK | P. 417 |
| 3. PENDANT 150 | P. 489 | 7. FLOOR | P. 419 |
| 4. PENDANT 200 | P. 489 | | |



JOEL COLLECTION

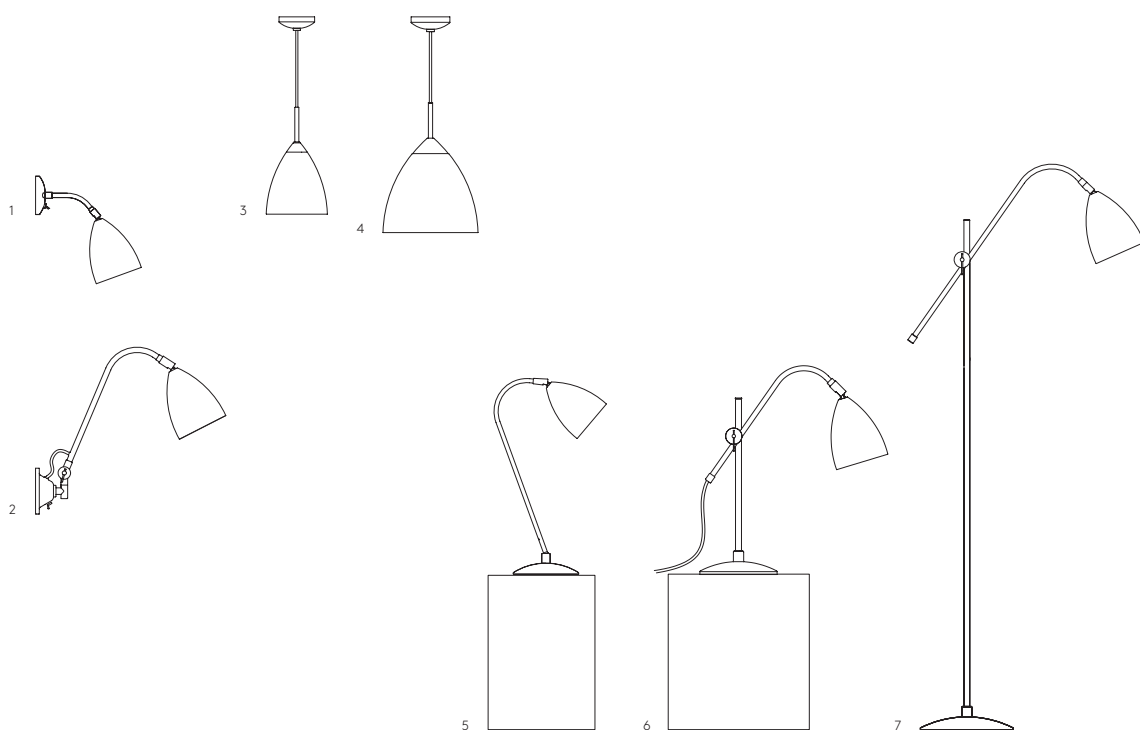

- 1. WALL P. 287
- 2. GRANDE WALL P. 289
- 3. PENDANT 170 P. 491
- 4. PENDANT 270 P. 491

- 5. TABLE P. 420
- 6. GRANDE TABLE P. 421
- 7. FLOOR P. 423



TELEGRAPH COLLECTION

GB The products on these pages are sold without shade to enable the user to mix and match the shades and bases.

FR Les luminaires décrits dans ces pages sont vendus sans abat-jour. Ceci permet d'assortir et de combiner luminaire et abat-jour.

DE Die Produkte auf diesen Seiten werden ohne Schirme geliefert, so dass Schirme und Leuchten nach Belieben kombiniert werden können.

IT I prodotti illustrati nelle presenti pagine sono venduti privi di paralume, per consentire al cliente di abbinare il corpo con il paralume della tonalità preferita.

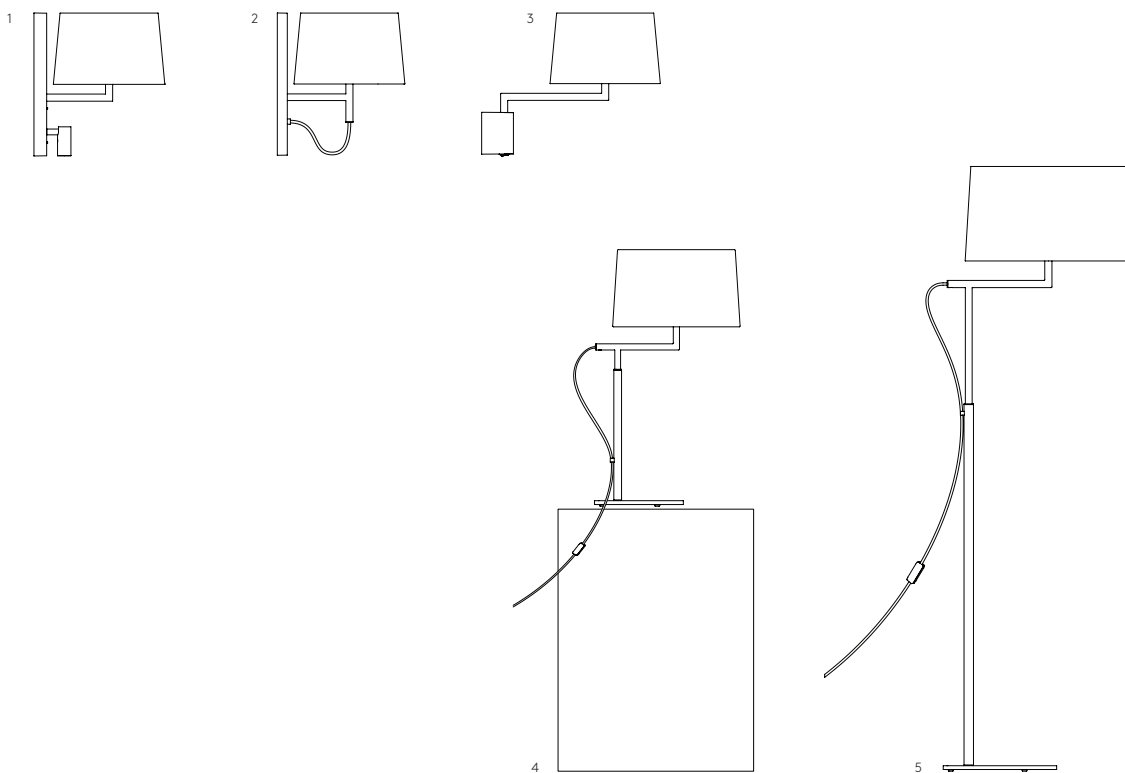

1. READER P. 255

2. WALL P. 251

3. SWING P. 295

4. TABLE P. 402

5. FLOOR P. 403



RAVELLO COLLECTION

GB The products on these pages are sold without shade to enable the user to mix and match the shades and bases.

FR Les luminaires décrits dans ces pages sont vendus sans abat-jour. Ceci permet d'assortir et de combiner luminaire et abat-jour.

DE Die Produkte auf diesen Seiten werden ohne Schirme geliefert, so dass Schirme und Leuchten nach Belieben kombiniert werden können.

IT I prodotti illustrati nelle presenti pagine sono venduti privi di paralume, per consentire al cliente di abbinare il corpo con il paralume della tonalità preferita.

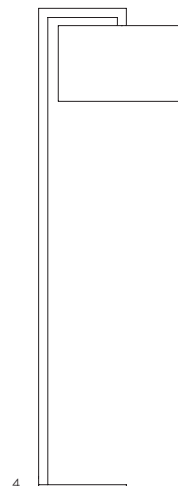
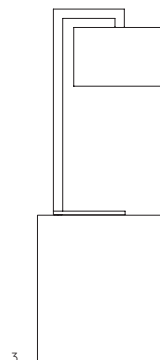
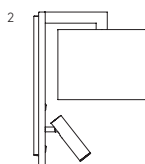
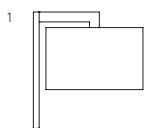

- 1. WALL [P. 251](#)
- 2. LED READER [P. 301](#)
- 3. TABLE [P. 427](#)
- 4. FLOOR [P. 429](#)



AZUMI COLLECTION

GB The products on these pages are sold without shade to enable the user to mix and match the shades and bases.

FR Les luminaires décrits dans ces pages sont vendus sans abat-jour. Ceci permet d'assortir et de combiner luminaire et abat-jour.

DE Die Produkte auf diesen Seiten werden ohne Schirme geliefert, so dass Schirme und Leuchten nach Belieben kombiniert werden können.

IT I prodotti illustrati nelle presenti pagine sono venduti privi di paralume, per consentire al cliente di abbinare il corpo con il paralume della tonalità preferita.

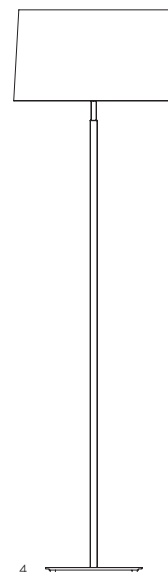
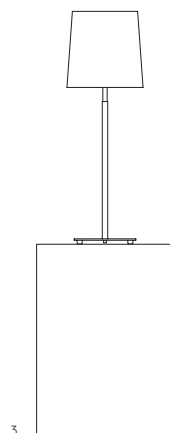
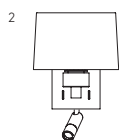
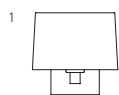

- 1. CLASSIC P. 253
- 2. READER P. 303
- 3. TABLE P. 430
- 4. FLOOR P. 431



PARK LANE COLLECTION

GB The products on these pages are sold without shade to enable the user to mix and match the shades and bases.

FR Les luminaires décrits dans ces pages sont vendus sans abat-jour. Ceci permet d'assortir et de combiner luminaire et abat-jour.

DE Die Produkte auf diesen Seiten werden ohne Schirme geliefert, so dass Schirme und Leuchten nach Belieben kombiniert werden können.

IT I prodotti illustrati nelle presenti pagine sono venduti privi di paralume, per consentire al cliente di abbinare il corpo con il paralume della tonalità preferita.

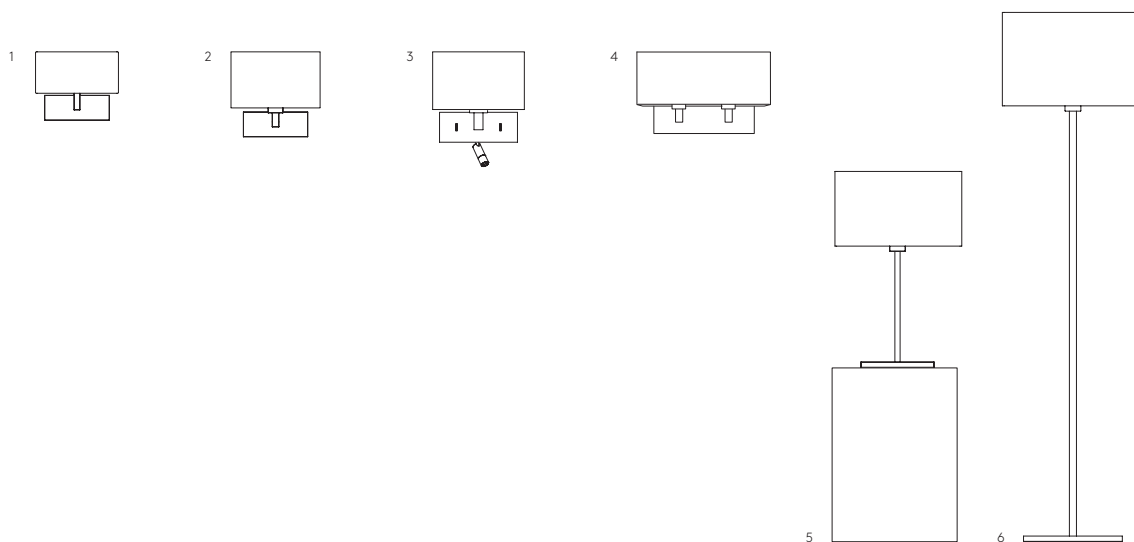

- | | | | |
|--------------|--------|----------|--------|
| 1. PARK LANE | P. 245 | 4. TWIN | P. 249 |
| 2. GRANDE | P. 247 | 5. TABLE | P. 432 |
| 3. READER | P. 305 | 6. FLOOR | P. 433 |





WALL

APPLIQUES MURALES • WANDLEUCHTEN • LAMPADE DA PARETE



NEW
CARMEL
P. 221



LIMA
P. 223



CASERTA
P. 225



VALBONNE
P. 227



BEAUVILLE
P. 229



GAUDI
P. 231



TATE
P. 233



MONTCLAIR TWIN
P. 234



DELPHI SINGLE
P. 235



RIVA 350
P. 237



LAGO 280
P. 239



NAPOLI
P. 241



CONNAUGHT
P. 243



PARK LANE
P. 245



PARK LANE GRANDE
P. 247



PARK LANE TWIN
P. 249



RAVELLO WALL
P. 251



AZUMI CLASSIC
P. 253



NEW
TELEGRAPH WALL
P. 255



NEW
TELEGRAPH SWING
P. 257



SAN MARINO SOLO
P. 259



NEW
MITSU SWING ARM
P. 261



NEW
MITSU WALL
P. 263



CHUO
P. 265



PETRA
P. 267



IOS
P. 268



ASHINO
P. 269



CREMONA
P. 271



NEW
KINZO LED
P. 273



NEW
YUMA LED
P. 275



NEW
HARVARD WALL
P. 277



NEW
BOSTON
P. 279



NEW
VERSAILLES
P. 281



ATELIER WALL
P. 283



ATELIER GRANDE WALL
P. 285



JOEL WALL
P. 287



JOEL GRANDE WALL
P. 289



● **NEW**
SIDE BY SIDE
P. 293



● **NEW**
TELEGRAPH
READER
P. 295



● NAPOLI
READER
P. 297



● NAPOLI LED
P. 299



● RAVELLO LED
P. 301



● AZUMI
READER
P. 303



● PARK LANE
READER
P. 305



● SALA LED
P. 307



● ENNA WALL
P. 309



● ENNA SQUARE
P. 311



● ENNA SURFACE
P. 313



● ENNA RECESS
P. 315



● **NEW**
MICRO RECESS
P. 317



● FUSE
P. 319



● DIGIT
P. 321



● TOSCA
P. 323



● LEO SWITCHED
P. 325



● FOSSO
P. 327



● LINDOS
P. 329



● EDGE READER MINI
P. 331



● EDGE READER
P. 333



● PARMA 100/110
P. 339



● PARMA 160/210
P. 341



● PARMA 250/625
P. 343



● RIO
P. 345



● PELLA
P. 347



● PIENZA
P. 349



● KOZZA
P. 351



● KYMI
P. 353



● PERO
P. 355



● MOSTO
P. 355



● BRENTA
P. 357



● BOLOGNA
P. 359



● SERIFOS
P. 361



● ECLIPSE ROUND
P. 363



● ECLIPSE SQUARE
P. 365



● ARIA
P. 365



● KYO
P. 367



● OVARO
P. 367



● GOSFORD
P. 369



MILO
P. 371



AMALFI
P. 373



● D-LIGHT
P. 375



S-LIGHT
P. 375



● EDGE
P. 377



CYL
P. 379



LUGA
P. 381



OBROUND
P. 381



TOKYO
P. 383



● **NEW**
RENOIR
P. 385



● MONDRIAN FRAME
P. 387



● MONDRIAN
P. 389



TEETOO
P. 391



● GOYA
P. 393



● LEROS TRIMLESS
P. 397



● OLYMPUS TRIMLESS
P. 397



● BORGO TRIMLESS
P. 399



● BORGO TRIMLESS
P. 399



● BORGO
P. 401



● BORGO
P. 401



● TANGO
P. 403





CARMEL (1405001)



CARMEL GRANDE (1405004)



NEW

CARMEL

SHADE EXCLUDED

				LAMP	WATT	CLASS	
CARMEL	MN 1405001	Br 1405002		E14 LED ▼	7W max		✓
GRANDE	MN 1405003	Br 1405004		E27 LED ▼	12W max		✓

CARMEL

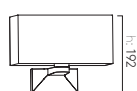

w: 250 d:154

RECTANGLE 250

- WF 5001005
- BF 5001006
- OF 5001013
- PF -



w: 177 d:192

TAPERED DRUM 177

- WF 5013001
- BF 5013002
- OF 5013003
- PF 5013006

CARMEL GRANDE

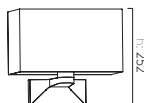

w: 285 d:198

RECTANGLE 285

- WF 5001001
- BF 5001003
- OF 5001007
- PF 5001017

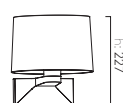

w: 215 d:230

TAPERED ROUND 215

- WF 5006001
- BF 5006002
- OF 5006003
- PF 5006004

P. 687: SPECIAL SHADE COLOURS
Couleurs spéciales / Sonderfarben / Colori speciali

▼ LAMP EXCLUDED, SEE PAGE 685 / La lampe exclu, voir page 685 / La lampadina esclusi a pagina 685 / Das Leuchtmittel ist ausgeschlossen, sie auf Seite 685.





LIMA (1318001 + 5026001)



LIMA (1318009 + 5026003)



LIMA

SHADE EXCLUDED

	LAMP	WATT	CLASS	
PCh 1318001 MN 1318002 Br 1318009	E27 LED ▼	12W max		✓

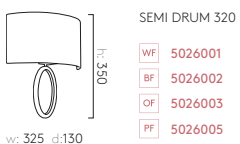

P. 687: SPECIAL SHADE COLOURS
 Couleurs spéciales / Sonderfarben / Colori speciali

▼ LAMP EXCLUDED, SEE PAGE 685 / La lampe exclu, voir page 685 / La lampadina esclusi a pagina 685 / Das Leuchtmittel ist ausgeschlossen, sie auf Seite 685.





CASERTA (1349010 + 5026003)



CASERTA (1349001 + 5026002)



CASERTA

SHADE EXCLUDED

PCh 1349001		MN 1349002		Br 1349010		MG 1349005		LAMP	WATT	CLASS	
PCh 1349001		MN 1349002		Br 1349010		MG 1349005		E27 LED ▼	12W max		✓

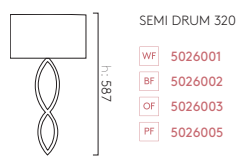

w: 320 d:128

P. 687: SPECIAL SHADE COLOURS
Couleurs spéciales / Sonderfarben / Colori speciali

▼ LAMP EXCLUDED, SEE PAGE 685 / La lampe exclu, voir page 685 / La lampadina esclusi a pagina 685 / Das Leuchtmittel ist ausgeschlossen, sie auf Seite 685.





VALBONNE (1356001 + 5029003)



VALBONNE (1356007 + 5029002)



VALBONNE

SHADE EXCLUDED

	LAMP	WATT	CLASS	
<p>PCh 1356001 MN 1356003 Br 1356007</p>	E27 LED ▼	12W max		✓

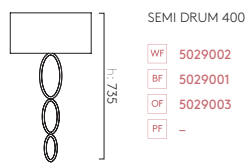

w: 400 d: 143

P. 687: SPECIAL SHADE COLOURS
Couleurs spéciales / Sonderfarben / Colori speciali

▼ LAMP EXCLUDED, SEE PAGE 685 / La lampe exclu, voir page 685 / La lampadina esclusi a pagina 685 / Das Leuchtmittel ist ausgeschlossen, sie auf Seite 685.





BEAUVILLE (1388001 + 5033003)



BEAUVILLE (1388001 + 5033002)



BEAUVILLE

SHADE EXCLUDED

	PCh	Br	LAMP	WATT	CLASS	
	1388001	1388002	E27 LED ▼	12W max		✓

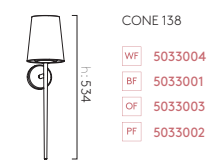

w: 138 d: 162

P. 687: SPECIAL SHADE COLOURS
Couleurs spéciales / Sonderfarben / Colori speciali

▼ LAMP EXCLUDED, SEE PAGE 685 / La lampe exclu, voir page 685 / La lampadina esclusi a pagina 685 / Das Leuchtmittel ist ausgeschlossen, sie auf Seite 685.





GAUDI (1385003 + 5026002)



GAUDI (1385002 + 5026003)

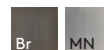

GAUDI

SHADE EXCLUDED

	LAMP	WATT	CLASS	
Br 1385003 MN 1385002	E27 LED ▼	12W max		✓

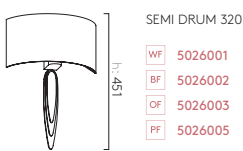

w: 325 d:130

P. 687: SPECIAL SHADE COLOURS
Couleurs spéciales / Sonderfarben / Colori speciali

▼ LAMP EXCLUDED, SEE PAGE 685 / La lampe exclu, voir page 685 / La lampadina esclusi a pagina 685 / Das Leuchtmittel ist ausgeschlossen, sie auf Seite 685.





TATE (1334003 + 5026002)



TATE (1334007 + 5026003)

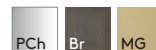

TATE

SHADE EXCLUDED

	LAMP	WATT	CLASS	
PCh 1334002 Br 1334007 MG 1334003	E27 LED ▼	12W max		✓

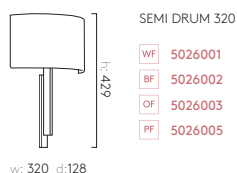

P. 687: SPECIAL SHADE COLOURS
Couleurs spéciales / Sonderfarben / Colori speciali

▼ LAMP EXCLUDED, SEE PAGE 685 / La lampe exclu, voir page 685 / La lampadina esclusi a pagina 685 / Das Leuchtmittel ist ausgeschlossen, sie auf Seite 685.



MONTCLAIR TWIN (1364006 + 5013003)



MONTCLAIR TWIN (1364005 + 5013002)



MONTCLAIR TWIN

SHADE EXCLUDED

			LAMP	WATT	CLASS	
PCh 1364004	MN 1364005	Br 1364006	E27 LED ▼	2 x 12W max		✓

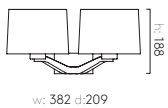

TAPERED DRUM 177

- WF** 5013001
- BF** 5013002
- OF** 5013003
- PF** 5013006

P. 687: SPECIAL SHADE COLOURS
Couleurs spéciales / Sonderfarben / Colori speciali

▼ LAMP EXCLUDED, SEE PAGE 685 / La lampe exclu, voir page 685 / La lampadina esclusi a pagina 685 / Das Leuchtmittel ist ausgeschlossen, sie auf Seite 685.



DELPHI SINGLE (1313002 + 5018011)



DELPHI SINGLE (1313002 + 5018012)



DELPHI SINGLE

SHADE EXCLUDED

1313002

LAMP	WATT	CLASS		
E27 LED	12W max			

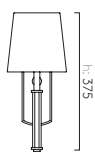

w: 160 d: 197

CONE 160

- 5018011
- 5018012
- 5018013
-

P. 687: SPECIAL SHADE COLOURS
Couleurs spéciales / Sonderfarben / Colori speciali

▼ LAMP EXCLUDED, SEE PAGE 685 / La lampe exclu, voir page 685 / La lampadina esclusi a pagina 685 / Das Leuchtmittel ist ausgeschlossen, sie auf Seite 685.





RIVA 350 (1214001 + 5018004)



RIVA 350 (1214010 + 5018014)



RIVA 350

SHADE EXCLUDED

				LAMP	WATT	IP	CLASS		
1214001	1214004	1214010	1214008	E27 LED ▼	12W max	44		✓	✓

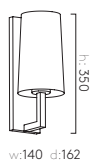

CONE 240

- 5018007
- 5018004
- 5018015
-
- 5018014

P. 687: SPECIAL SHADE COLOURS
Couleurs spéciales / Sonderfarben / Colori speciali

▼ LAMP EXCLUDED, SEE PAGE 685 / La lampe exclu, voir page 685 / La lampadina esclusi a pagina 685 / Das Leuchtmittel ist ausgeschlossen, sie auf Seite 685.





LAGO 280 (1297002 + 5018001)



LAGO 280 (1297001 + 5019001)



LAGO 280

SHADE EXCLUDED

			LAMP	WATT	IP	CLASS					
PCh	1297001	MN	1297002	Br	1297007	E27 LED ▼	12W max	44		✓	✓

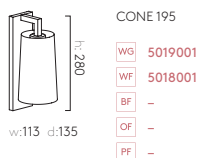

P. 687: SPECIAL SHADE COLOURS
Couleurs spéciales / Sonderfarben / Colori speciali

▼ LAMP EXCLUDED, SEE PAGE 685 / La lampe exclu, voir page 685 / La lampadina esclusi a pagina 685 / Das Leuchtmittel ist ausgeschlossen, sie auf Seite 685.





NAPOLI (1185001 + 5014001)



NAPOLI (1185001 + 5014003)

MN

NAPOLI

SHADE EXCLUDED

	LAMP	WATT	CLASS	
MN 1185001	E27 LED ▼	12W max		✓

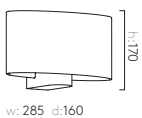

OVAL 285

- WF 5014001
- BF 5014002
- OF 5014003
- PF 5014004

P. 687: SPECIAL SHADE COLOURS
Couleurs spéciales / Sonderfarben / Colori speciali

▼ LAMP EXCLUDED, SEE PAGE 685 / La lampe exclu, voir page 685 / La lampadina esclusi a pagina 685 / Das Leuchtmittel ist ausgeschlossen, sie auf Seite 685.





CONNAUGHT + WHITE SHADE (1099004)



CONNAUGHT + BLACK SHADE (1099003)



CONNAUGHT

		LAMP	WATT	CLASS	
WHITE SHADE	1099004	E14 LED ▼	7W max		✓
BLACK SHADE	1099003	E14 LED ▼	7W max		✓

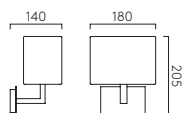

CONNAUGHT

▼ LAMP EXCLUDED, SEE PAGE 685 / La lampe exclu, voir page 685 / La lampadina esclusi a pagina 685 / Das Leuchtmittel ist ausgeschlossen, sie auf Seite 685.





PARK LANE + BLACK SHADE (1080002)



PARK LANE

	PCh	MN	Br	LAMP	WATT	CLASS	🔌
WHITE SHADE	1080011	1080009	1080044	E14 LED▼	7W max	⚡	✓
BLACK SHADE	1080002	1080022		E14 LED▼	7W max	⚡	✓

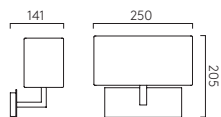

PARK LANE

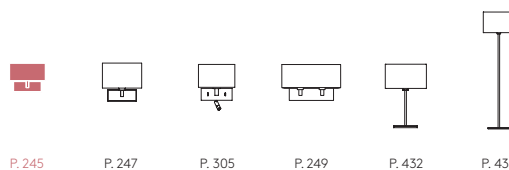

Oyster coloured shades (ref: 5001013) available to order separately. / Les abat-jours couleur coquille d'huître (ref: 5001013) peuvent être commandés séparément. / Schirme in der Farbe Oyster (Art. Nr.: 5001013) können separat bestellt werden. / Sono disponibili paralumi di colore 'oyster' (ref: 5001013), da ordinare separatamente.

▼ LAMP EXCLUDED, SEE PAGE 685 / La lampe exclu, voir page 685 / La lampadina esclusi a pagina 685 / Das Leuchtmittel ist ausgeschlossen, sie auf Seite 685.



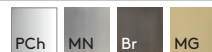

PARK LANE GRANDE

SHADE EXCLUDED

	LAMP	WATT	CLASS						
<table border="0"> <tr> <td>PCh 1080004</td> <td>MN 1080007</td> <td>Br 1080045</td> <td>MG 1080032</td> <td></td> </tr> </table>	PCh 1080004	MN 1080007	Br 1080045	MG 1080032		E27 LED ▼	12W max		✓
PCh 1080004	MN 1080007	Br 1080045	MG 1080032						

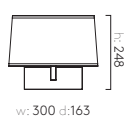
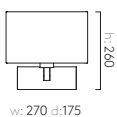

RECTANGLE 285

- WF** 5001001
- BF** 5001003
- OF** 5001007
- PF** 5001017

TAPERED OVAL*

- WF** 5034001
- BF** 5034002
- OF** 5034003
- PF** 5034004

P. 687: SPECIAL SHADE COLOURS
Couleurs spéciales / Sonderfarben / Colori speciali

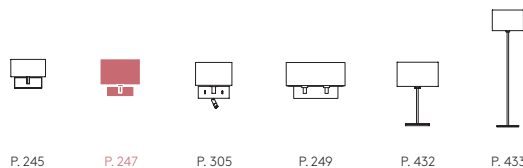

* TO BE USED WITH LED/CFL LAMP ONLY / Pour utilisation avec lampe LED/CFL seulement. / nur mit Kompaktleuchtstofflampe /LED verwenden / Solo per l'uso con lampade a LED/CFL.

▼ LAMP EXCLUDED, SEE PAGE 685 / La lampe exclu, voir page 685 / La lampadina esclusi a pagina 685 / Das Leuchtmittel ist ausgeschlossen, sie auf Seite 685.





PARK LANE TWIN (1080020 + 5001016)



PARK LANE TWIN

SHADE EXCLUDED

			LAMP	WATT	CLASS	
PCh 1080019	MN 1080020	Br 1080048	E27 LED ▼	2 x 12W max		✓

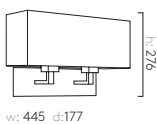

- PARK LANE TWIN SHADE
- WF** 5001014
 - BF** 5001015
 - OF** 5001016
 - PF** 5001029

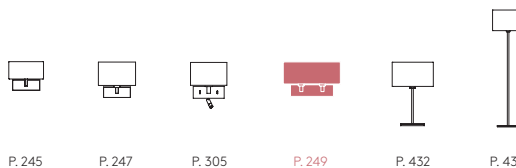

P. 687: SPECIAL SHADE COLOURS
Couleurs spéciales / Sonderfarben / Colori speciali

▼ LAMP EXCLUDED, SEE PAGE 685 / La lampe exclu, voir page 685 / La lampadina esclusi a pagina 685 / Das Leuchtmittel ist ausgeschlossen, sie auf Seite 685.





RAVELLO WALL (1222012 + 5015007)



RAVELLO WALL (1222040 + 5016009)

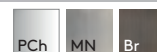

RAVELLO WALL

SHADE EXCLUDED

LAMP WATT CLASS

PCh 1222012 **MN** 1222013 **Br** 1222040

E27 LED ▾ 12W max

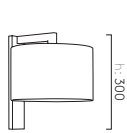

w: 250 d: 282

DRUM 250

- WF** 5016007
- BF** 5016008
- OF** 5016009
- PF** 5016019

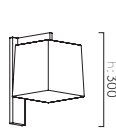

w: 175 d: 245

RAVELLO TAPERED SQUARE 175

- WF** 5030004
- BF** 5030003
- OF** 5030005
- PF** 5030006

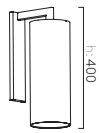

w: 135 d: 225

TUBE 135

- WF** 5015004
- BF** 5015005
- OF** 5015006
- PF** 5015007

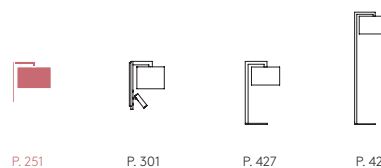

▾ LAMP EXCLUDED, SEE PAGE 685 / La lampe exclu, voir page 685 / La lampadina esclusi a pagina 685 / Das Leuchtmittel ist ausgeschlossen, sie auf Seite 685.

P. 687: SPECIAL SHADE COLOURS / Couleurs spéciales / Sonderfarben / Colori speciali





AZUMI CLASSIC (1142015 + 5006001)



AZUMI CLASSIC

SHADE EXCLUDED

Br 1142015 PN 1142016 MN 1142017

LAMP WATT CLASS

E27 LED 12W max

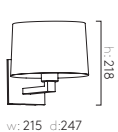

TAPERED ROUND 215

- 5006001
- 5006002
- 5006003
- 5006004



TAPERED SQUARE 175

- 5005001
- 5005002
- 5005003
- 5005004

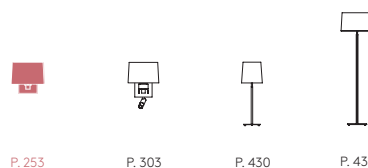

P. 687: SPECIAL SHADE COLOURS
Couleurs spéciales / Sonderfarben / Colori speciali

▼ LAMP EXCLUDED, SEE PAGE 685 / La lampe exclu, voir page 685 / La lampadina esclusi a pagina 685 / Das Leuchtmittel ist ausgeschlossen, sie auf Seite 685.





TELEGRAPH WALL (1404010)



TELEGRAPH WALL (1404011)



NEW TELEGRAPH WALL

SHADE EXCLUDED

	LAMP	WATT	CLASS
MB 1404010 MN 1404011 Br 1404012	E27 LED ▼	12W max	✓



TAPERED ROUND 250

- WF 5035003
- BF 5035004
- OF -
- PF 5035005

w: 250 d: 287

P. 687: SPECIAL SHADE COLOURS
Couleurs spéciales / Sonderfarben / Colori speciali

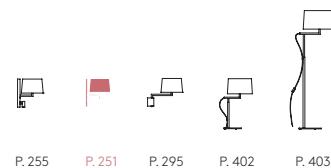

▼ LAMP EXCLUDED, SEE PAGE 685 / La lampe exclu, voir page 685 / La lampadina esclusi a pagina 685 / Das Leuchtmittel ist ausgeschlossen, sie auf Seite 685.





TELEGRAPH SWING (1404001 + 5035005)

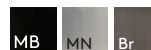

NEW TELEGRAPH SWING

SHADE EXCLUDED

			LAMP	WATT	CLASS	
MB 1404001	MN 1404002	Br 1404003	E27 LED ▼	12W max		✓

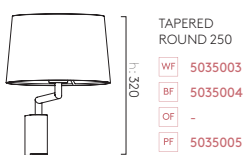

w: 250 d: 405

P. 687: SPECIAL SHADE COLOURS
Couleurs spéciales / Sonderfarben / Colori speciali

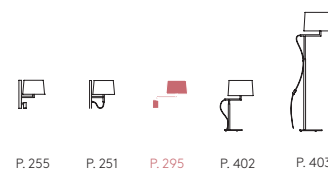

▼ LAMP EXCLUDED, SEE PAGE 685 / La lampe exclu, voir page 685 / La lampadina esclusi a pagina 685 / Das Leuchtmittel ist ausgeschlossen, sie auf Seite 685.





SAN MARINO SOLO (1076005 + 5013001)



SAN MARINO SOLO (1076007 + 5015001)



SAN MARINO SOLO

SHADE EXCLUDED

LAMP WATT CLASS

Br 1076007 PCh 1076005 MN 1076006

G9 LED ▼ 3W max ✓

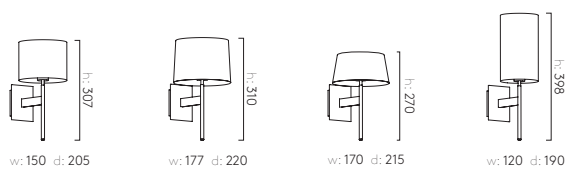

DRUM 150

- WF 5016001
- BF 5016002
- OF 5016003
- PF -

TAPERED DRUM 177

- WF 5013001
- BF 5013002
- OF 5013003
- PF 5013006

TAPERED DRUM 95

- WF -
- BF 5013004
- OF 5013005
- PF -

TUBE 120

- WF 5015001
- BF 5015002
- OF 5015003
- PF -

P. 687: SPECIAL SHADE COLOURS / Couleurs spéciales / Sonderfarben / Colori speciali

▼ LAMP EXCLUDED, SEE PAGE 685 / La lampe exclu, voir page 685 / La lampadina esclusi a pagina 685 / Das Leuchtmittel ist ausgeschlossen, sie auf Seite 685.





NEW

MITSU SWING ARM

		LAMP	WATT	CLASS
MN 1394001	Br 1394002	E27 LED▼	12W max	⊕

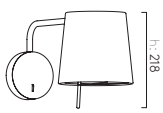

- CONE 173
- WF 5018031
 - BF 5018032
 - OF -
 - PF 5018034

w: 173 d: 406

P. 687: SPECIAL SHADE COLOURS
Couleurs spéciales / Sonderfarben / Colori speciali

▼ LAMP EXCLUDED, SEE PAGE 685 / La lampe exclu,
voir page 685 / La lampadina esclusi a pagina 685 /
Das Leuchtmittel ist ausgeschlossen, sie auf Seite 685.

LED





NEW

MITSU WALL

MN 1394003 Br 1394004

LAMP E27 LED
 WATT 12W max
 CLASS Ⓢ

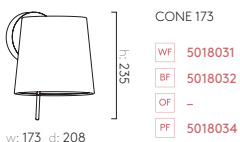

- WF 5018031
- BF 5018032
- OF -
- PF 5018034

P. 687: SPECIAL SHADE COLOURS
 Couleurs spéciales / Sonderfarben / Colori speciali

▼ LAMP EXCLUDED, SEE PAGE 685 / La lampe exclu, voir page 685 / La lampadina esclusi a pagina 685 / Das Leuchtmittel ist ausgeschlossen, sie auf Seite 685.





CHUO SQUARE 250 (5024007 + 1367003)



CHUO RECTANGLE 190 (5024006 + 1367002)



CHUO

			BACKPLATE EXCL.	LAMP	WATT	CLASS	🔄
RECTANGLE 380	WF 5024001	OF 5024003	Backplate 1 - 1367001	E27 LED ▼	2 x 12W max	⊕	✓
SQUARE 250	WF 5024007	OF 5024009	Backplate 3 - 1367003	E27 LED ▼	12W max	⊕	✓
RECTANGLE 190	WF 5024004	OF 5024006	Backplate 2 - 1367002	E27 LED ▼	12W max	⊕	✓

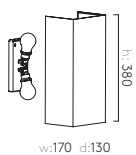

CHUO RECTANGLE 380

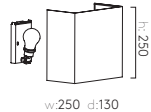

CHUO SQUARE 250

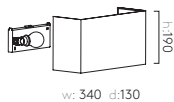

CHUO RECTANGLE 190

P. 687: SPECIAL SHADE COLOURS / Couleurs spéciales / Sonderfarben / Colori speciali

▼ LAMP EXCLUDED, SEE PAGE 685 / La lampe exclu, voir page 685 / La lampadina esclusi a pagina 685 / Das Leuchtmittel ist ausgeschlossen, sie auf Seite 685.





PETRA 180 (5027001 + 1367003)



PETRA 180 (5027003 + 1367003)



PETRA 180

	BACKPLATE EXCL.	LAMP	WATT	CLASS	
WF 5027001 OF 5027003	Backplate 3 - 1367003	E27 LED ▼	12W max	⊕	✓

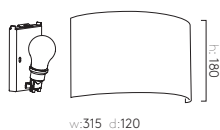

w:315 d:120

P. 687: SPECIAL SHADE COLOURS
 Couleurs spéciales / Sonderfarben / Colori speciali

▼ LAMP EXCLUDED, SEE PAGE 685 / La lampe exclu, voir page 685 / La lampadina esclusi a pagina 685 / Das Leuchtmittel ist ausgeschlossen, sie auf Seite 685.



IOS 250 (5028001 + 1367003)



IOS 250

		BACKPLATE EXCL.	LAMP	WATT	CLASS	
WF 5028001	OF 5028003	Backplate 3 - 1367003	E27 LED ▼	12W max	⚡	✓

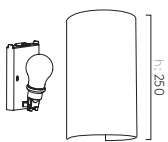

w:144 d:120

 P. 687: SPECIAL SHADE COLOURS
Couleurs spéciales / Sonderfarben / Colori speciali

▼ LAMP EXCLUDED, SEE PAGE 685 / La lampe exclu, voir page 685 / La lampadina esclusi a pagina 685 / Das Leuchtmittel ist ausgeschlossen, sie auf Seite 685.



ASHINO (1166001)



ASHINO WIDE (1166002)

WF

ASHINO

		LAMP	WATT	CLASS		
ASHINO	1166001	E14 LED▼	7W max		✓	✓
ASHINO WIDE	1166002	E27 LED▼	12W max		✓	-

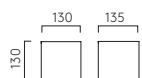

ASHINO

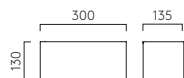

ASHINO WIDE

▼ LAMP EXCLUDED, SEE PAGE 685 / La lampe exclu, voir page 685 / La lampadina esclusi a pagina 685 / Das Leuchtmittel ist ausgeschlossen, sie auf Seite 685.





CREMONA (1067001)



CREMONA

W 1067001

LAMP	WATT	CLASS	
E14 LED ▼	7W max		✓

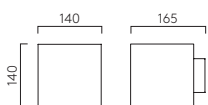

CREMONA

▼ LAMP EXCLUDED, SEE PAGE 685 / La lampe exclu, voir page 685 / La lampadina esclusi a pagina 685 / Das Leuchtmittel ist ausgeschlossen, sie auf Seite 685.

LED





KINZO LED 110 (1398003)

KINZO LED 260 (1398016)



NEW

KINZO LED

					LAMP	WATT	INPUT	K	CRI	Lm	CLASS		
110	TB 1398001	TW 1398002	MN 1398003	Br 1398004	Integral LED	5.9W	Mains 230V	2700	80	167	⊕	Phase	✓
210	TB 1398005	TW 1398006	MN 1398007	Br 1398008	Integral LED	11.6W	Mains 230V	2700	80	322	⊕	Phase	✓
260	TB 1398013	TW 1398014	MN 1398015	Br 1398016	Integral LED	15.1W	Mains 230V	2700	80	449	⊕	Phase	✓
300	TB 1398009	TW 1398010	MN 1398011	Br 1398012	Integral LED	11.7W	Mains 230V	2700	80	186	⊕	Phase	✓

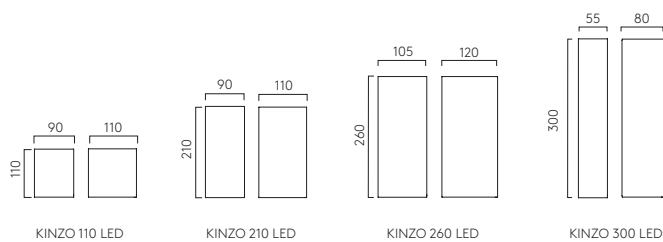

LED





YUMA 120 LED (1399007)



YUMA 240 LED (1399009)

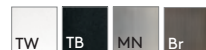

NEW

YUMA LED

						LAMP	WATT	INPUT	K	CRI	Lm	CLASS		
120	TW 1399005	TB 1399006	MN 1399007	Br 1399008	Integral LED	7.6W	Mains 230V	2700	80	435	⊕	Phase	✓	
240	TW 1399009	TB 1399010	MN 1399011	Br 1399012	Integral LED	15W	Mains 230V	2700	80	892	⊕	Phase	✓	
300	TW 1399001	TB 1399002	MN 1399003	Br 1399004	Integral LED	11.8W	Mains 230V	2700	80	388	⊕	Phase	✓	

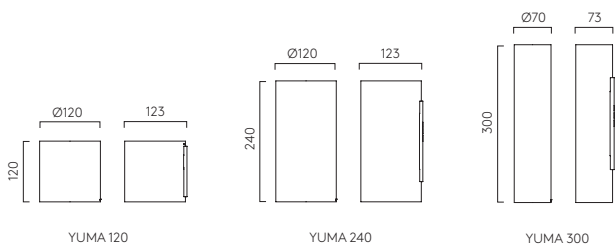





HARVARD WALL (1402002)



HARVARD WALL (1402004)



HARVARD WALL (1402001)



NEW

HARVARD WALL

	LAMP	WATT	CLASS	IP		
PSS 1402002 Br 1402004 MB 1402005 NB 1402001	E27 ▼	4W max		44	✓	✓

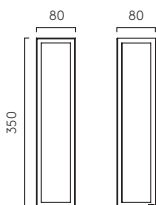

HARVARD WALL

▼ LAMP EXCLUDED, SEE PAGE 685 / La lampe exclu, voir page 685 / La lampadina esclusi a pagina 685 / Das Leuchtmittel ist ausgeschlossen, sie auf Seite 685.

LED





BOSTON (1370002)



BOSTON (1370005)



BOSTON

				LAMP	WATT	INPUT	K	CRI	Lm	IP	CLASS	Ⓢ	Ⓜ
370	PCh 1370002	Br 1370004		Integral LED	13.9W	Mains 230V	3000	80	465	44	□	✓	✓
600	PCh 1380003	Br 1380005		Integral LED	7.3W	Mains 230V	3000	80	740	44	□	✓	✓

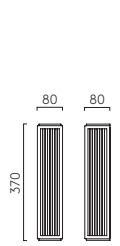

BOSTON 370

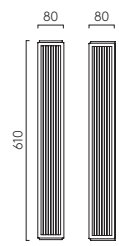

BOSTON 600

LED



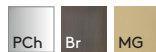

VERSAILLES

				LAMP	WATT	INPUT	K	CRI	Lm	IP	CLASS		
250	1380001	1380004	1380015	Integral LED	4.7W	Mains 230V	3000	80	371	44		✓	✓
370	1380013	1380014		Integral LED	15.1W	Mains 230V	3000	80	609	44		✓	✓
400	1380002	1380003	1380016	Integral LED	7.3W	Mains 230V	3000	80	740	44		✓	✓
600	1380011	1380012		Integral LED	25W	Mains 230V	3000	80	1078	44		✓	✓

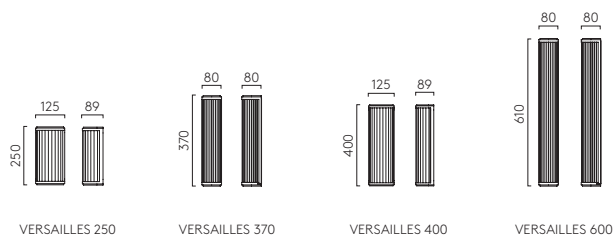





ATELIER WALL (1224011)



ATELIER WALL (1224012)



ATELIER WALL

	LAMP	WATT	CLASS		
PA 1224011	E27 LED	12W max		✓	✓
MW 1224012					
MB 1224013					

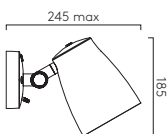

ATELIER WALL

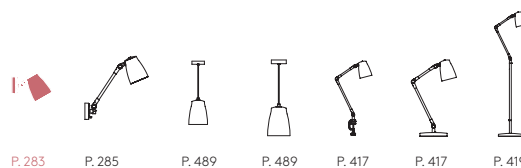

▼ LAMP EXCLUDED, SEE PAGE 685 / La lampe exclu, voir page 685 / La lampadina esclusi a pagina 685 / Das Leuchtmittel ist ausgeschlossen, sie auf Seite 685.





ATELIER GRANDE WALL (1224016)



ATELIER GRANDE WALL (1224014)



ATELIER GRANDE WALL

	LAMP	WATT	CLASS		
PA 1224014	E27 LED	12W max			
MW 1224015					
MB 1224016					

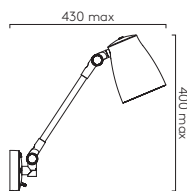

SUPPLIED WITH REMOVABLE PLUG AND LEAD SET. / Fourni avec prise et cordon amovibles. / Inklusive abnehmbarem Stecker und Kabel. / Fornito con cavo e spina rimovibile.

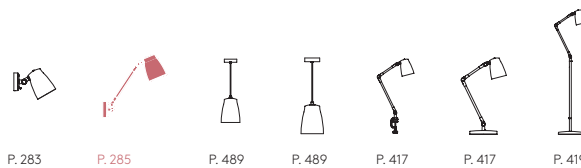

▼ LAMP EXCLUDED, SEE PAGE 685 / La lampe exclu, voir page 685 / La lampadina esclusi a pagina 685 / Das Leuchtmittel ist ausgeschlossen, sie auf Seite 685.





JOEL WALL (1223014)

MB Cr

JOEL WALL

		LAMP	WATT	CLASS		
MB 1223014	Cr 1223015	E27 LED	12W max		<input checked="" type="checkbox"/>	<input checked="" type="checkbox"/>

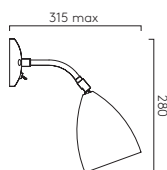

JOEL WALL

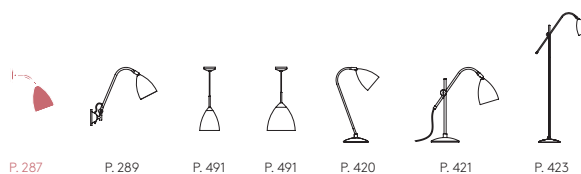

▼ LAMP EXCLUDED, SEE PAGE 685 / La lampe exclu, voir page 685 / La lampadina esclusi a pagina 685 / Das Leuchtmittel ist ausgeschlossen, sie auf Seite 685.





JOEL GRANDE WALL (1223021)

MB Cr

JOEL GRANDE WALL

		LAMP	WATT	CLASS	
MB 1223022	Cr 1223021	E27 LED ▼	12W max	□	✓

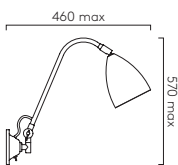

JOEL GRANDE WALL

SUPPLIED WITH REMOVABLE PLUG AND LEAD SET. / Fourni avec prise et cordon amovibles. / Inklusive abnehmbarem Stecker und Kabel. / Fornito con cavo e spina rimovibile.

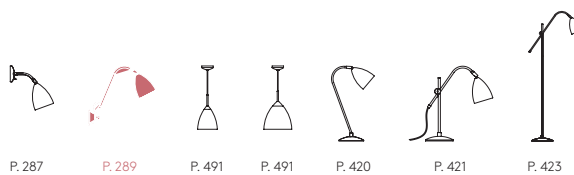

▼ LAMP EXCLUDED, SEE PAGE 685 / La lampe exclu, voir page 685 / La lampadina esclusi a pagina 685 / Das Leuchtmittel ist ausgeschlossen, sie auf Seite 685.



READING

LISEUSES • LESELEUCHTEN • LUCI DI LETTURA



● **NEW**
SIDE BY SIDE
P. 293



● **NEW**
TELEGRAPH
READER
P. 295



●
NAPOLI
READER
P. 297



●
NAPOLI LED
P. 299



●
RAVELLO LED
P. 301



●
AZUMI
READER
P. 303



●
PARK LANE
READER
P. 305



●
SALA LED
P. 307



●
ENNA WALL
P. 309



●
ENNA SQUARE
P. 311



●
ENNA SURFACE
P. 313



●
ENNA RECESS
P. 315



● **NEW**
MICRO RECESS
P. 317



●
FUSE
P. 319



●
DIGIT
P. 321



●
TOSCA
P. 323



●
LEO SWITCHED
P. 325



●
FOSSO
P. 327



●
LINDOS
P. 329



●
EDGE READER MINI
P. 331



●
EDGE READER
P. 333

LED





SIDE BY SIDE (1406004 + 5018037)



SIDE BY SIDE (1406002 + 5018037)

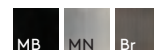

NEW

SIDE BY SIDE

	LAMP	WATT	INPUT	K	CRI	CLASS	
MB 1406002 MN 1406003 Br 1406004	E27 LED [▼] + Integral LED (4.1W)	12W max	Mains 230V	2700	80		

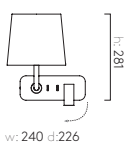

CONE 180

- WF 5018035
- BF 5018036
- OF -
- PF 5018037

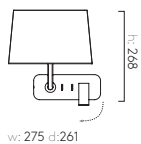

TAPERED ROUND 250

- WF 5035003
- BF 5035004
- OF -
- PF 5035005

P. 687: SPECIAL SHADE COLOURS
Couleurs spéciales / Sonderfarben / Colori speciali

CAN BE MOUNTED EITHER WAY ROUND / Montage reversible (gauche/droite) / Kann beidseitig montiert werden / Può essere montato anche rivolto verso l'alto.

▼ LAMP EXCLUDED, SEE PAGE 685 / La lampe exclu, voir page 685 / La lampadina esclusi a pagina 685 / Das Leuchtmittel ist ausgeschlossen, sie auf Seite 685.

LED

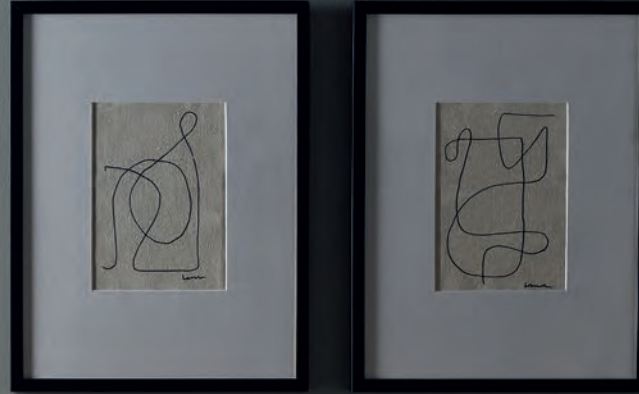



TELEGRAPH READER (1404014 + 5035005)

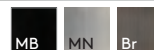

NEW TELEGRAPH READER

SHADE EXCLUDED

			LAMP	WATT	INPUT	K	CRI	CLASS	
MB 1404013	MN 1404014	Br 1404015	E27 LED [▼] + Integral LED (2W)	12W max	Mains 230V	2700	80		



- TAPERED ROUND 250
- WF** 5035003
 - BF** 5035004
 - OF** -
 - PF** 5035005

w: 250 d: 293

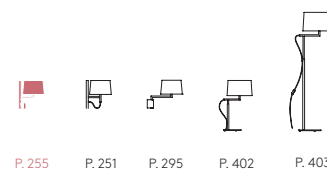

P. 687: SPECIAL SHADE COLOURS
Couleurs spéciales / Sonderfarben / Colori speciali

[▼] LAMP EXCLUDED, SEE PAGE 685 / La lampe exclu, voir page 685 / La lampadina esclusi a pagina 685 / Das Leuchtmittel ist ausgeschlossen, sie auf Seite 685.

LED





NAPOLI READER (1185003 + 5014001)



NAPOLI READER

SHADE EXCLUDED

	LAMP	WATT	INPUT	K	CRI	CLASS	
MN 1185003	E27 LED ▽ + Integral LED (2W)	12W max	Mains 230V	2700	80		<input checked="" type="checkbox"/>

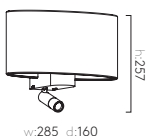

- OVAL 285
- WF** 5014001
 - BF** 5014002
 - OF** 5014003
 - PF** 5014004

P. 687: SPECIAL SHADE COLOURS
Couleurs spéciales / Sonderfarben / Colori speciali

▽ LAMP EXCLUDED, SEE PAGE 685 / La lampe exclu, voir page 685 / La lampadina esclusi a pagina 685 / Das Leuchtmittel ist ausgeschlossen, sie auf Seite 685.

LED





NAPOLI LED (1185002 + 5014002)



NAPOLI LED (1185002 + 5014003)

MN

NAPOLI LED

SHADE EXCLUDED

	LAMP	WATT	INPUT	K	CRI	CLASS	
MN 1185002	E27 LED▼ + Integral LED (1W)	12W max	Mains 230V	3000	80		✓

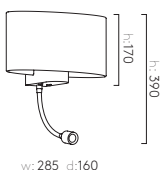

- OVAL 285
- 5014001
 - 5014002
 - 5014003
 - 5014004

P. 687: SPECIAL SHADE COLOURS
Couleurs spéciales / Sonderfarben / Colori speciali

▼ LAMP EXCLUDED, SEE PAGE 685 / La lampe exclu, voir page 685 / La lampadina esclusi a pagina 685 / Das Leuchtmittel ist ausgeschlossen, sie auf Seite 685.

LED

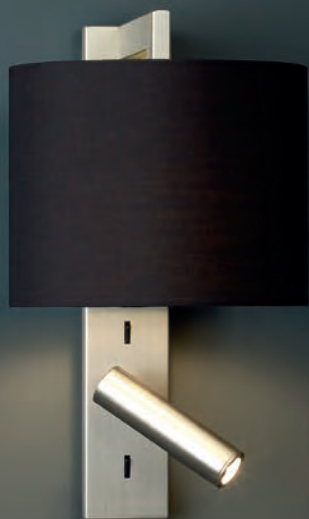



RAVELLO LED READER (1222018 + 5016020)



RAVELLO LED READER (1222020 + 5016021)



RAVELLO LED READER

SHADE EXCLUDED

	LAMP	WATT	INPUT	K	CRI	Lm	CLASS
PCh 1222018	MN 1222019	Br 1222020	E27 LED▼ + Integral LED (2W)	12W max	Mains 230V	2700	80 111

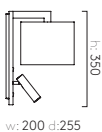

DRUM 200

- WF** 5016020
- BF** 5016021
- OF** 5016022
- PF** 5016029

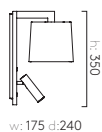

RAVELLO TAPERED SQUARE 175

- WF** 5030004
- BF** 5030003
- OF** 5030005
- PF** 5030006

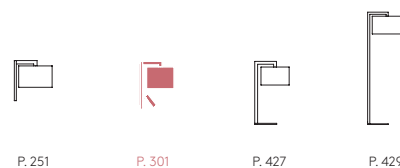

P. 687: SPECIAL SHADE COLOURS
Couleurs spéciales / Sonderfarben / Colori speciali

▼ LAMP EXCLUDED, SEE PAGE 685 / La lampe exclu, voir page 685 / La lampadina esclusi a pagina 685 / Das Leuchtmittel ist ausgeschlossen, sie auf Seite 685.

LED





AZUMI READER (1142033 + 5006003)



AZUMI READER (1142034 + 5005003)



AZUMI READER

SHADE EXCLUDED

	LAMP	WATT	INPUT	K	CRI	Lm	CLASS	
PCh 1142033 MN 1142034 Br 1142048	E27 LED▼ + Integral LED (2.2W)	12W max	Mains 230V	2700	80	76		

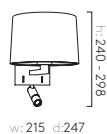

TAPERED ROUND 215

- WF 5006001
- BF 5006002
- OF 5006003
- PF 5006004

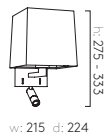

TAPERED SQUARE 175

- WF 5005001
- BF 5005002
- OF 5005003
- PF 5005004

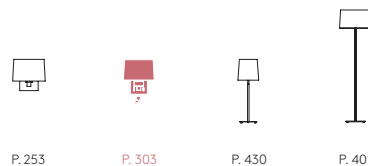

P. 687: SPECIAL SHADE COLOURS
Couleurs spéciales / Sonderfarben / Colori speciali

▼ LAMP EXCLUDED, SEE PAGE 685 / La lampe exclu, voir page 685 / La lampadina esclusi a pagina 685 / Das Leuchtmittel ist ausgeschlossen, sie auf Seite 685.

LED





PARK LANE READER (1080029 + 5001007)



PARK LANE READER (1080031 + 5001001)



PARK LANE READER

SHADE EXCLUDED

	LAMP	WATT	INPUT	K	CRI	Lm	CLASS								
<table border="0"> <tr> <td>PCh 1080029</td> <td>MN 1080030</td> <td>Br 1080031</td> <td>E27 LED[▼] + Integral LED (2.2W)</td> <td>12W max</td> <td>Mains 230V</td> <td>2700</td> <td>80 76 </td> </tr> </table>	PCh 1080029	MN 1080030	Br 1080031	E27 LED [▼] + Integral LED (2.2W)	12W max	Mains 230V	2700	80 76							
PCh 1080029	MN 1080030	Br 1080031	E27 LED [▼] + Integral LED (2.2W)	12W max	Mains 230V	2700	80 76								

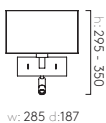

RECTANGLE 285

- WF 5001001
- BF 5001003
- OF 5001007
- PF 5001017

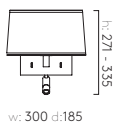

TAPERED OVAL*

- WF 5034001
- BF 5034002
- OF 5034003
- PF 5034004

P. 687: SPECIAL SHADE COLOURS
Couleurs spéciales / Sonderfarben / Colori speciali

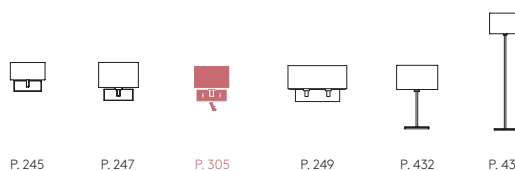

* TO BE USED WITH CFL/LED LAMP ONLY / Pour utilisation avec lampe CFL/LED seulement. / nur mit Kompaktleuchtstofflampe /LED verwenden / Solo per l'uso con lampada a CFL/LED.

[▼] LAMP EXCLUDED, SEE PAGE 685 / La lampe exclu, voir page 685 / La lampadina esclusi a pagina 685 / Das Leuchtmittel ist ausgeschlossen, sie auf Seite 685.





SALA LED (1114002)



SALA LED

	LAMP	WATT	INPUT	K	CRI	CLASS	
PCh 1114002	E14 LED▼ + Integral LED (1W)	7W max	Mains 230V	3000	80	⊕	✓

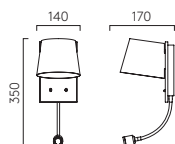

SALA LED

▼ LAMP EXCLUDED, SEE PAGE 685 / La lampe exclu, voir page 685 / La lampadina esclusi a pagina 685 / Das Leuchtmittel ist ausgeschlossen, sie auf Seite 685.

LED

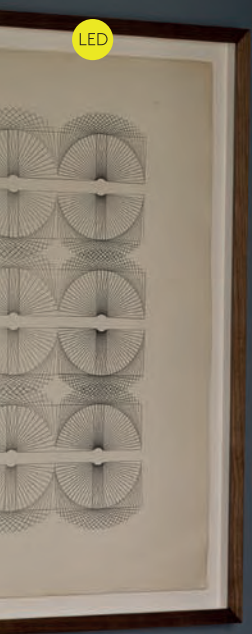



ENNA WALL (1058056)



ENNA WALL (1058033)



ENNA WALL (1058032)



ENNA WALL

	LAMP	WATT	INPUT	K	CRI	Lm	CLASS
MW 1058032 MB 1058033 MN 1058056 MG 1058105	Integral LED	4.7W	Mains 230V	2700	80	105	

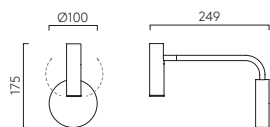

ENNA WALL

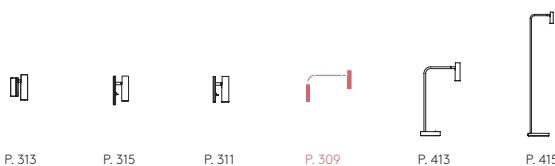

LED





ENNA SQUARE SWITCHED (1058018)



ENNA SQUARE SWITCHED (1058085)



ENNA SQUARE SWITCHED (1058016)



ENNA SQUARE SWITCHED

			LAMP	WATT	INPUT	K	CRI	Lm	CLASS	
MW 1058016	Br 1058085	MN 1058018	Integral LED	4.5W	Mains 230V	2700	80	111	⊕	✓
PCh 1058019	MB 1058024	MG 1058030								

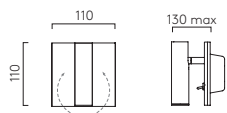

ENNA SQUARE SWITCHED

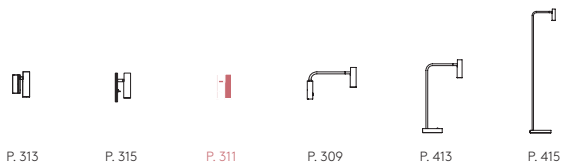

THIS PRODUCT IS AVAILABLE WITHOUT A SWITCH BY SPECIAL ORDER WITH A MINIMUM ORDER QUANTITY OF 100 PCS / Cet article est disponible sans interrupteur dans le cadre d'une commande spéciale, pour une quantité minimum de 100 pièces. / Dieses Produkt ist ohne Schalter bei Bestellung einer Mindestbestellmenge von 100 Stück verfügbar. / Questo articolo è disponibile senza interruttore solo dietro ordine speciale con quantità minima di 100 pz.

LED





ENNA SURFACE (1058084)



ENNA SURFACE (1058027)



ENNA SURFACE

			LAMP	WATT	INPUT	K	CRI	Lm	CLASS	
Br 1058084	MN 1058013	PCh 1058014	Integral LED	4.5W	Mains 230V	2700	80	111	⊕	✓
MW 1058015	MB 1058027	MG 1058108								

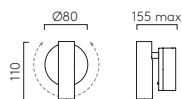

ENNA SURFACE

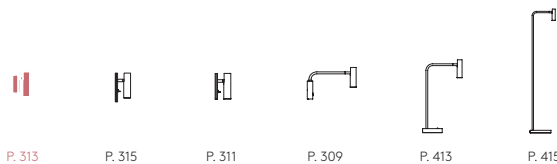

THIS PRODUCT IS AVAILABLE WITHOUT A SWITCH BY SPECIAL ORDER WITH A MINIMUM ORDER QUANTITY OF 100 PCS / Cet article est disponible sans interrupteur dans le cadre d'une commande spéciale, pour une quantité minimum de 100 pièces. / Dieses Produkt ist ohne Schalter bei Bestellung einer Mindestbestellmenge von 100 Stück verfügbar. / Questo articolo è disponibile senza interruttore solo dietro ordine speciale con quantità minima di 100 pz.

LED





ENNA RECESS SWITCHED (1058064)



ENNA RECESS SWITCHED (1058062)



ENNA RECESS SWITCHED

	LAMP	WATT	INPUT	K	CRI	Lm	CLASS	
MW 1058062 PCh 1058064 MN 1058065 Br 1058066 MB 1058067	Integral LED	3.9W	Mains 230V	2700	80	151	⊕	✓

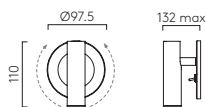

ENNA RECESS SWITCHED

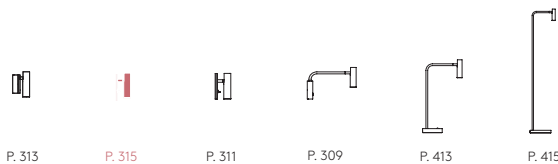

THIS PRODUCT IS AVAILABLE WITHOUT A SWITCH BY SPECIAL ORDER WITH A MINIMUM ORDER QUANTITY OF 100 PCS / Cet article est disponible sans interrupteur dans le cadre d'une commande spéciale, pour une quantité minimum de 100 pièces. / Dieses Produkt ist ohne Schalter bei Bestellung einer Mindestbestellmenge von 100 Stück verfügbar. / Questo articolo è disponibile senza interruttore solo dietro ordine speciale con quantità minima di 100 pz.

LED





MICRO RECESS SWITCHED (1407010)



MICRO RECESS UNSWITCHED (1407003)



NEW MICRO RECESS

						LAMP	WATT	INPUT	K	CRI	Lm	CLASS	
SWITCHED	MW 1407006	MB 1407007	MN 1407008	Br 1407009	MG 1407010	Integral LED	3.4W	700mA▼	2700	80	166	⊕	✓
UNSWITCHED	MW 1407001	MB 1407002	MN 1407003	Br 1407004	MG 1407005	Integral LED	3.2W	700mA▼	2700	80	164	⊕	-

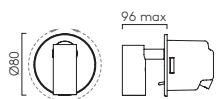

MICRO RECESS SWITCHED

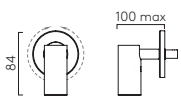

MICRO RECESS UNSWITCHED

▼ DRIVER EXCLUDED, SEE PAGE 683. Driver d'entrée exclu, voir page 683. / Driver esclusi a pagina 683. / Das treiber ist ausgeschlossen, sie auf Seite 683.

LED





FUSE SWITCHED (1215035)



FUSE SWITCHED (1215038)



FUSE SWITCHED LED

PCh 1215035
 Br 1215038
 MW 1215036
 MB 1215037
 MN 1215039

LAMP WATT INPUT K CRI Lm CLASS

Integral LED 4.2W Mains 230V 2700 80 171 ✓ ✓

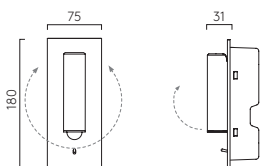

FUSE SWITCHED LED

THIS PRODUCT IS AVAILABLE WITHOUT A SWITCH BY SPECIAL ORDER WITH A MINIMUM ORDER QUANTITY OF 100 PCS / Cet article est disponible sans interrupteur dans le cadre d'une commande spéciale, pour une quantité minimum de 100 pièces. / Dieses Produkt ist ohne Schalter bei Bestellung einer Mindestbestellmenge von 100 Stück verfügbar. / Questo articolo è disponibile senza interruttore solo dietro ordine speciale con quantità minima di 100 pz.

LED



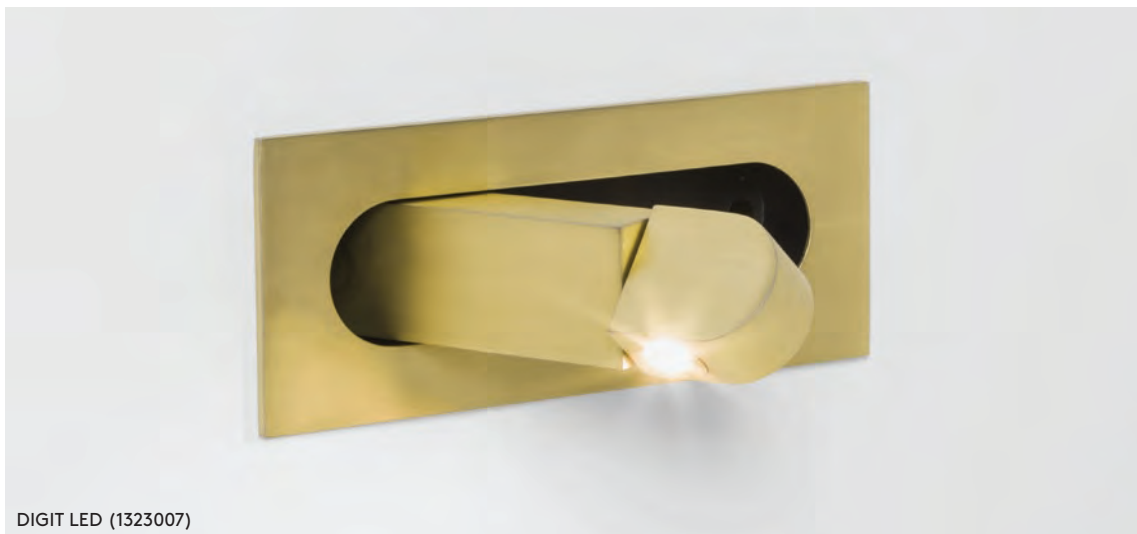

DIGIT LED (1323007)



DIGIT LED II (1323010)



DIGIT

				LAMP	WATT	INPUT	K	CRI	Lm	CLASS	□	⊕	
LED	MG	1323007		Integral LED	3.9W	Mains 230V	2700	80	114	□	✓	✓	
LED II	MN	1323012	Br	1323011	PCh	1323010					⊕	✓	✓

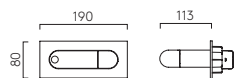

DIGIT LED / LED II

CAN BE MOUNTED EITHER WAY ROUND / Montage reversible (gauche/droite) / Kann beidseitig montiert werden / Può essere montato anche rivolto verso l'alto.

LED





TOSCA (1157002)



TOSCA (1157003)

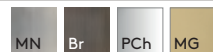

TOSCA

	LAMP	WATT	INPUT	K	CRI	Lm	CLASS		
MN 1157001	Integral LED	2.2W	Mains 230V	2700	80	61		⊕	✓ ✓
Br 1157012									
PCh 1157003									
MG 1157007									

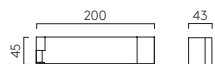

TOSCA

CAN BE MOUNTED EITHER WAY ROUND / Montage reversible (gauche/droite) / Kann beidseitig montiert werden / Può essere montato anche rivolto verso l'alto.

LED





LEO SWITCHED (1295002)



LEO SWITCHED

	LAMP	WATT	INPUT	K	CRI	Lm	CLASS	⏻	⚡
PCh 1295001 MN 1295002 Br 1295003	Integral LED	4W	Mains 230V	3000	80	193	Ⓛ	✓	✓

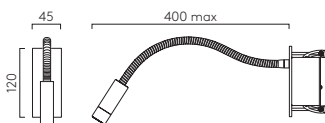

LEO SWITCHED

THIS PRODUCT IS AVAILABLE WITHOUT A SWITCH BY SPECIAL ORDER WITH A MINIMUM ORDER QUANTITY OF 100 PCS / Cet article est disponible sans interrupteur dans le cadre d'une commande spéciale, pour une quantité minimum de 100 pièces. / Dieses Produkt ist ohne Schalter bei Bestellung einer Mindestbestellmenge von 100 Stück verfügbar. / Questo articolo è disponibile senza interruttore solo dietro ordine speciale con quantità minima di 100 pz.

LED





FOSSO SWITCHED (1138011)

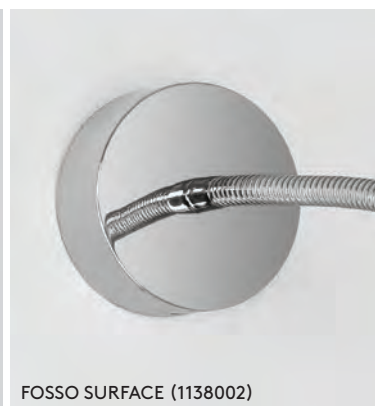

FOSSO SURFACE (1138002)



FOSSO SWITCHED (1138005)

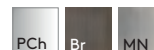

FOSSO

				LAMP	WATT	INPUT	K	CRI	Lm	CLASS	
SWITCHED*	PCh 1138005	Br 1138011	MN 1138008	Integral LED	2.5W	Mains 230V	3000	80	90	⊕	✓
SURFACE	PCh 1138002			Integral LED	2.5W	Mains 230V	3000	80	90	⊕	-

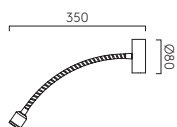

FOSSO

*THIS PRODUCT IS AVAILABLE WITHOUT A SWITCH BY SPECIAL ORDER WITH A MINIMUM ORDER QUANTITY OF 100 PCS / Cet article est disponible sans interrupteur dans le cadre d'une commande spéciale, pour une quantité minimum de 100 pièces. / Dieses Produkt ist ohne Schalter bei Bestellung einer Mindestbestellmenge von 100 Stück verfügbar. / Questo articolo è disponibile senza interruttore solo dietro ordine speciale con quantità minima di 100 pz.

LED





LINDOS SWITCHED (1316007)



LINDOS SWITCHED (1316010)



LINDOS SWITCHED

	LAMP	WATT	INPUT	K	CRI	Lm	CLASS	
PCh 1316007 MN 1316008 Br 1316010	Integral LED	2.3W	Mains 230V	3000	80	113	□	✓

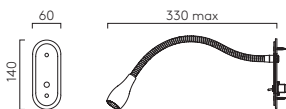

LINDOS SWITCHED

THIS PRODUCT IS AVAILABLE WITHOUT A SWITCH BY SPECIAL ORDER WITH A MINIMUM ORDER QUANTITY OF 100 PCS / Cet article est disponible sans interrupteur dans le cadre d'une commande spéciale, pour une quantité minimum de 100 pièces. / Dieses Produkt ist ohne Schalter bei Bestellung einer Mindestbestellmenge von 100 Stück verfügbar. / Questo articolo è disponibile senza interruttore solo dietro ordine speciale con quantità minima di 100 pz.

LED





EDGE READER MINI (1352018)



EDGE READER MINI (1352019)



EDGE READER MINI

	LAMP	WATT	INPUT	K	CRI	Lm	CLASS		
MW 1352018	Reader	Integral LED	9.7W	Mains 230V	2700	80	112		✓ ✓
MB 1352019	Backlight	Integral LED	4.1W	Mains 230V	2700	80	149	-	✓ ✓

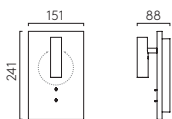

EDGE READER MINI

LED





EDGE READER (1352007)



EDGE READER

		LAMP	WATT	INPUT	K	CRI	Lm	CLASS		
EDGE READER	MW 1352007	Reader	Integral LED	14.8W	Mains 230V	2700	80	427	⊕	✓
		Backlight	Integral LED	4.1W	Mains 230V	2700	80	123	-	✓
SINGLE SWITCH	MW 1352008	Reader	Integral LED	15.7W	Mains 230V	2700	80	548	⊕	✓
		Backlight	Integral LED	4.1W	Mains 230V	2700	80	120	-	✓

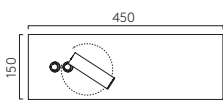

EDGE READER

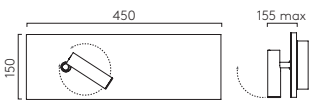

EDGE READER SINGLE SWITCH





PLASTER & CERAMIC

APPLIQUES EN PLÂTRE ET CÉRAMIQUE • GIPS - UND KERAMIKLEUCHTEN • LAMPADE IN GESSO E CERAMICA



●
PARMA 100/110
P. 339



●
PARMA 160/210
P. 341



●
PARMA 250/625
P. 343



●
RIO
P. 345



PELLA
P. 347



●
PIENZA
P. 349



KOZA
P. 351



KYMI
P. 353



PERO
P. 355



MOSTO
P. 355



BRENTA
P. 357



BOLOGNA
P. 359



●
SERIFOS
P. 361



●
ECLIPSE ROUND
P. 363



●
ECLIPSE SQUARE
P. 365



ARIA
P. 365



KYO
P. 367



OVARO
P. 367



GOSFORD
P. 369



MILO
P. 371



AMALFI
P. 373



S-LIGHT
P. 375



1. PARMA 210 P. 341
2. PARMA 210 P. 341
3. RIO 190 P. 345

4. PELLA 325 P. 347
5. SERIFOS 170 P. 361
6. PELLA 325 P. 347

7. BOLOGNA 160 P. 359
8. BOLOGNA 160 P. 359



5

7

8

6

LED





PARMA 110 (1187009)



PARMA 100 (1187004)



PARMA

		LAMP	WATT	INPUT	K	CRI	Lm	CLASS		
100	1187004	Integral LED	3.98W	Mains 230V	3000	80	104		-	✓
100	1187016	Integral LED	3.9W	Mains 230V	2700	80	76		-	-
110	1187009	GU10 LED▼	6W max	-	-	-	-		✓	-

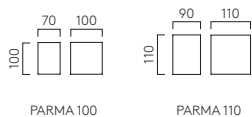

CAN BE PAINTED
Peut être peint / kann lackiert
werden / Può essere verniciato

▼ LAMP EXCLUDED, SEE PAGE 685 / La lampe exclu, voir
page 685 / La lampadina esclusi a pagina 685 / Das
Leuchtmittel ist ausgeschlossen, sie auf Seite 685.

LED





PARMA 160 (1187001)



PARMA 210 LED (1187019)

P

PARMA

		LAMP	WATT	INPUT	K	CRI	Lm	CLASS		
160	1187001	Integral LED	6.37W	Mains 230V	3000	80	134		-	✓
160	1187014	Integral LED	6.4W	Mains 230V	2700	80	155		-	✓
210	1187003	GU10 LED▼	6W max	-	-	-	-		✓	-
210 LED	1187019	Integral LED	8W	Mains 230V	2700	80	550		Phase + 1-10V	✓
210 LED	1187021	Integral LED	7.7W	Mains 230V	3000	80	503		Phase + 1-10V	✓

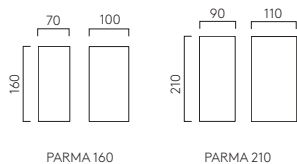

CAN BE PAINTED
 Peut être peint / kann lackiert
 werden / Può essere verniciato

▼ LAMP EXCLUDED, SEE PAGE 685 / La lampe exclu, voir
 page 685 / La lampadina esclusi a pagina 685 / Das
 Leuchtmittel ist ausgeschlossen, sie auf Seite 685.

LED

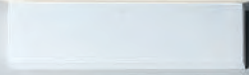

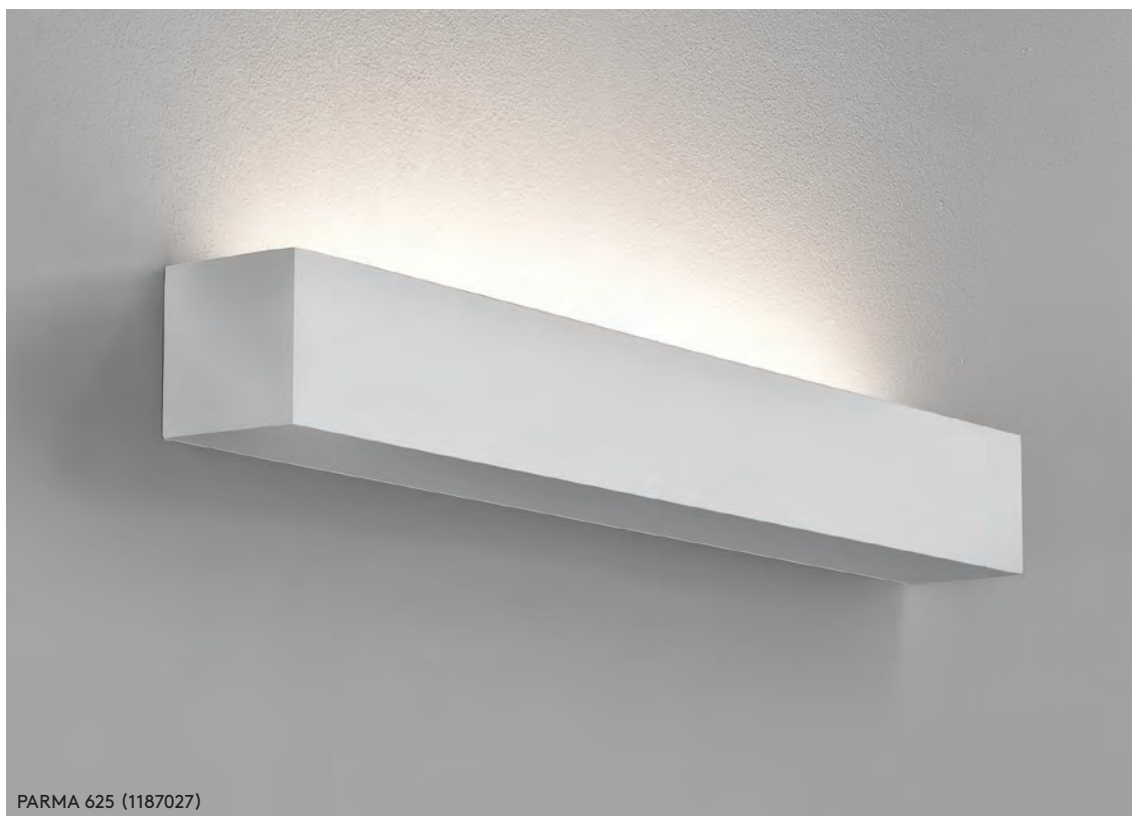

PARMA 625 (1187027)



PARMA

	LAMP	WATT	INPUT	K	CRI	Lm	CLASS		
200	1187005	E14 LED ▼	7W max	-	-	-		✓	-
250 LED	1187002	Integral LED	9.04W	Mains 230V	3000	80	301		- ✓
250 LED	1187015	Integral LED	8.7W	Mains 230V	2700	80	319		- ✓
625 LED	1187027	Integral LED	29.5W max	Mains 230V	2700	80	1497		✓ ✓

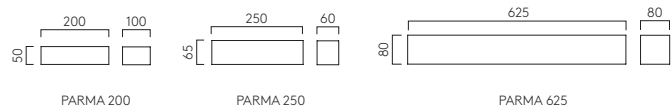

CAN BE PAINTED
 Peut être peint / kann lackiert werden / Può essere verniciato

▼ LAMP EXCLUDED, SEE PAGE 685 / La lampe exclu, voir page 685 / La lampadina esclusi a pagina 685 / Das Leuchtmittel ist ausgeschlossen, sie auf Seite 685.

LED





RIO 325 (1325009)



RIO 190 (1325002)



RIO

		LAMP	WATT	INPUT	K	CRI	Lm	CLASS		
125	1325007	Integral LED	5.7W	Mains 230V	2700	80	197		-	-
190	1325002	Integral LED	14.6W	Mains 230V	3000	80	1228		1-10V	✓
190	1325006	Integral LED	15.1W	Mains 230V	2700	80	1365		1-10V	-
190	1325010	Integral LED	16.6W	Mains 230V	2700	80	1637		Phase	✓
210	1325008	Integral LED	5.9W	Mains 230V	2700	80	195		-	-
325	1325001	Integral LED	14.7W	Mains 230V	3000	80	1198		1-10V	✓
325	1325005	Integral LED	15.1W	Mains 230V	2700	80	1133		1-10V	-
325	1325009	Integral LED	16.4W	Mains 230V	2700	80	1551		Phase	✓

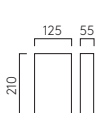

RIO 125

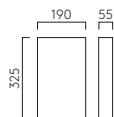

RIO 190

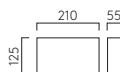

RIO 210

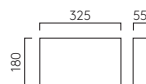

RIO 325



CAN BE PAINTED
Peut être peint / kann lackiert
werden / Può essere verniciato





PELLA 190 (1315002)



PELLA

		LAMP	WATT	CLASS	
190	1315002	GU10 LED ▼	2 x 6W max		✓
325	1315001	E27 LED ▼	12W max		✓

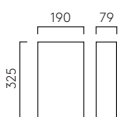

PELLA 190

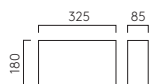

PELLA 325



CAN BE PAINTED
 Peut être peint / kann lackiert
 werden / Può essere verniciato

▼ LAMP EXCLUDED, SEE PAGE 685 / La lampe exclu, voir
 page 685 / La lampadina esclusi a pagina 685 / Das
 Leuchtmittel ist ausgeschlossen, sie auf Seite 685.

LED





PIENZA 165 (1196003)



PIENZA 140 SWITCHED (1196004)

P

PIENZA

		LAMP	WATT	INPUT	K	CRI	Lm	CLASS			
140	1196001	E14 LED ▼	7W max	-	-	-	-		✓	-	-
140 SWITCHED	1196004	E14 LED ▼	7W max	-	-	-	-		✓	✓	-
140 LED	1196002	Integral LED	6.24W	Mains 230V	3000	80	199		-	-	✓
140 LED	1196006	Integral LED	5.7W	Mains 230V	2700	80	357		-	-	✓
165	1196003	E27 LED ▼	12W max	-	-	-	-		✓	-	-

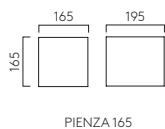
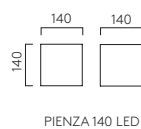
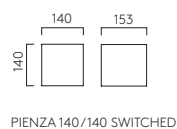

CAN BE PAINTED
 Peut être peint / kann lackiert werden / Può essere verniciato

▼ LAMP EXCLUDED, SEE PAGE 685 / La lampe exclu, voir page 685 / La lampadina esclusi a pagina 685 / Das Leuchtmittel ist ausgeschlossen, sie auf Seite 685.





KOZA (1155001)



KOZA (1155001)

P

KOZA

P 1155001

LAMP	WATT	CLASS			
E14 LED▼	7W max		✓	✓	✓

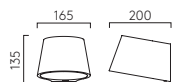

KOZA



CAN BE PAINTED
 Peut être peint / kann lackiert
 werden / Può essere verniciato

▼ LAMP EXCLUDED, SEE PAGE 685 / La lampe exclu, voir
 page 685 / La lampadina esclusi a pagina 685 / Das
 Leuchtmittel ist ausgeschlossen, sie auf Seite 685.

PRODUCT HAS BEEN PAINTED
Le produit a été peint
Das Produkt wurde lackiert
Il prodotto e' stato verniciato





KYMI 220 (1335001)



KYMI

		LAMP	WATT	CLASS	
220	1335001	GU10 LED▼	2 x 6W max		✓
300	1335003	GU10 LED▼	2 x 6W max		✓

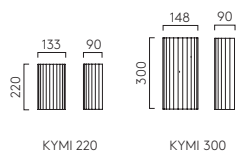

CAN BE PAINTED
Peut être peint / kann lackiert
werden / Può essere verniciato

▼ LAMP EXCLUDED, SEE PAGE 685 / La lampe exclu, voir
page 685 / La lampadina esclusi a pagina 685 / Das
Leuchtmittel ist ausgeschlossen, sie auf Seite 685.





PERO (1172001)



MOSTO (1173001)



PERO

	LAMP	WATT	CLASS	
P 1172001	G9 LED▼	3W max		✓

MOSTO

	LAMP	WATT	CLASS	
P 1173001	G9 LED▼	3W max		✓

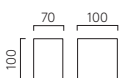

PERO

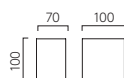

MOSTO



CAN BE PAINTED
Peut être peint / kann lackiert
werden / Può essere verniciato

▼ LAMP EXCLUDED, SEE PAGE 685 / La lampe exclu, voir
page 685 / La lampadina esclusi a pagina 685 / Das
Leuchtmittel ist ausgeschlossen, sie auf Seite 685.





BRENTA 130 (1195001)



BRENTA 175 (1195003)



BRENTA

		LAMP	WATT	CLASS		
130	1195001	E14 LED▼	7W max		✓	✓
175	1195003	E27 LED▼	12W max		✓	-

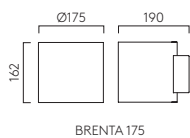
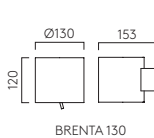

CAN BE PAINTED
Peut être peint / kann lackiert
werden / Può essere verniciato

▼ LAMP EXCLUDED, SEE PAGE 685 / La lampe exclu, voir
page 685 / La lampadina esclusi a pagina 685 / Das
Leuchtmittel ist ausgeschlossen, sie auf Seite 685.

LED

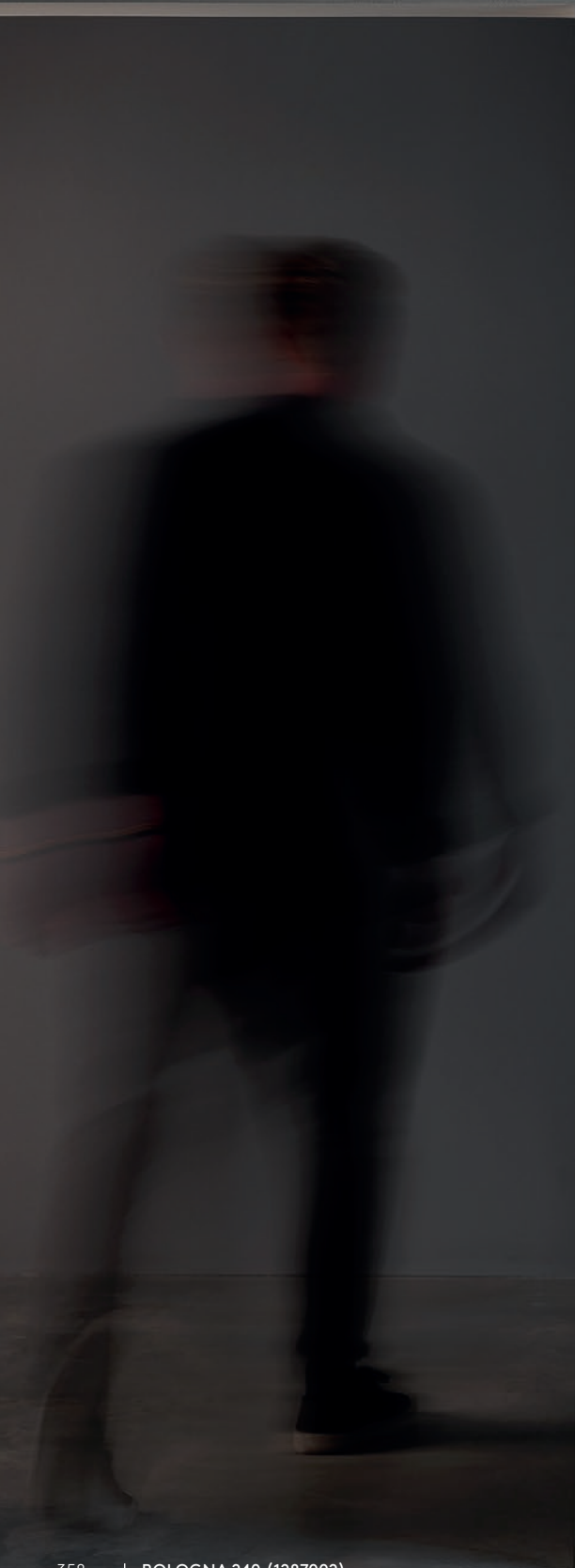



BOLOGNA 160 (1287001)



BOLOGNA

	LAMP	WATT	INPUT	K	CRI	Lm	CLASS		
160	1287001	Integral LED	6.42W	Mains 230V	3000	80	139		- ✓
240	1287002	GU10 LED ▼	2 x 6W max	-	-	-		✓ -	

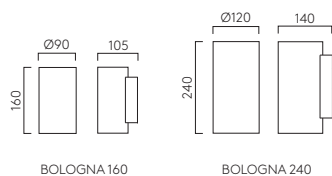

CAN BE PAINTED
 Peut être peint / kann lackiert
 werden / Può essere verniciato

▼ LAMP EXCLUDED, SEE PAGE 685 / La lampe exclu, voir
 page 685 / La lampadina esclusi a pagina 685 / Das
 Leuchtmittel ist ausgeschlossen, sie auf Seite 685.

LED





SERIFOS 170 (1350001)



SERIFOS

		LAMP	WATT	INPUT	K	CRI	Lm	CLASS		
170	1350001	Integral LED	6.32W	Mains 230V	3000	80	287		-	✓
170	1350002	Integral LED	6W	Mains 230V	2700	80	220		-	-
220	1350003	GU10 LED ▼	2 x 6W max	-	-	-	-		✓	-

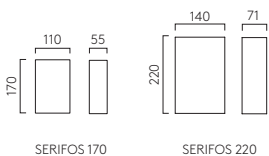

CAN BE PAINTED
Peut être peint / kann lackiert
werden / Può essere verniciato

▼ LAMP EXCLUDED, SEE PAGE 685 / La lampe exclu, voir
page 685 / La lampadina esclusi a pagina 685 / Das
Leuchtmittel ist ausgeschlossen, sie auf Seite 685.

LED



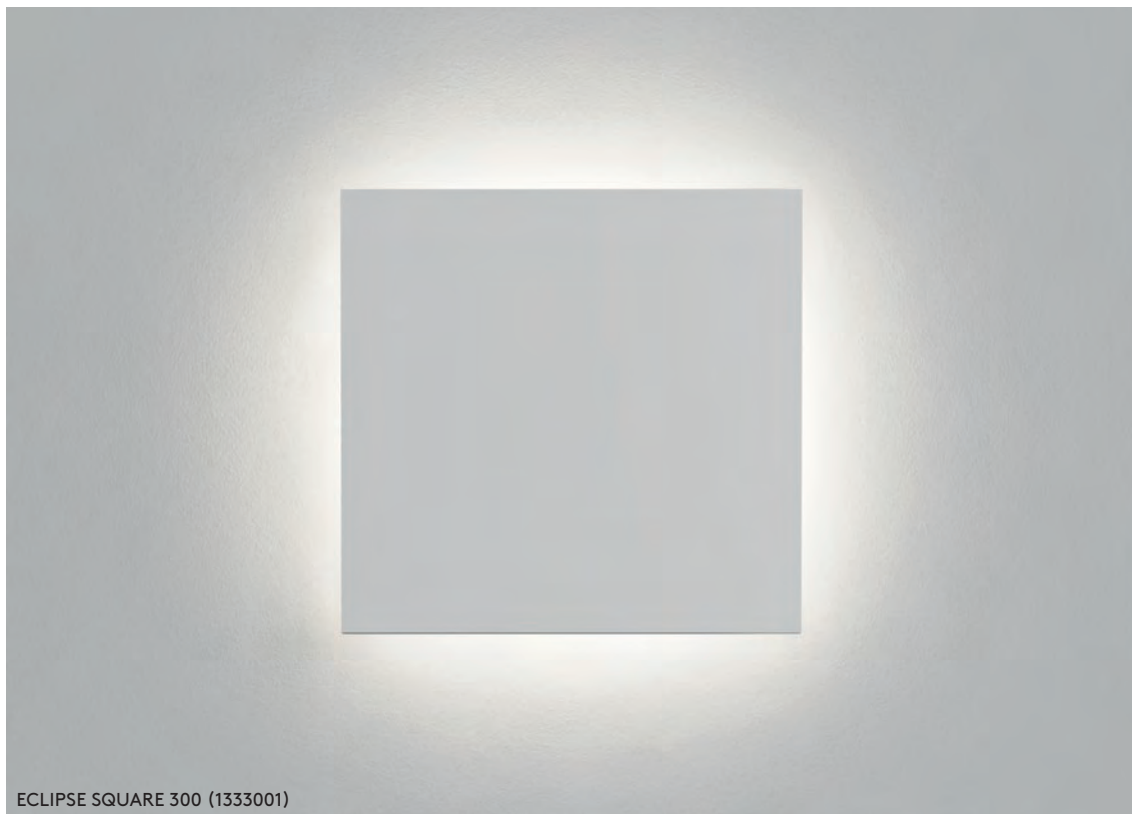

ECLIPSE SQUARE 300 (1333001)



ECLIPSE

		LAMP	WATT	INPUT	K	CRI	Lm	CLASS	
ROUND 250	1333002	Integral LED	10.44W	Mains 230V	3000	60	452		✓
ROUND 250	1333005	Integral LED	8.1W	Mains 230V	2700	60	357		-
ROUND 350	1333003	Integral LED	12.3W	Mains 230V	3000	60	432		✓
ROUND 350	1333006	Integral LED	12.3W	Mains 230V	2700	60	463		✓
SQUARE 300	1333001	Integral LED	15.08W	Mains 230V	3000	60	716		✓
SQUARE 300	1333004	Integral LED	12.2W	Mains 230V	2700	60	576		-

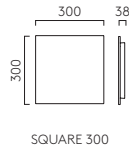
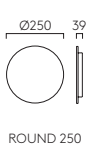

CAN BE PAINTED
Peut être peint / kann lackiert
werden / Può essere verniciato





ARIA 300 (1300001)



ARIA

		LAMP	WATT	CLASS	
300	1300001	E27 LED ▼	12W max		✓
370	1300002	E27 LED ▼	12W max		✓

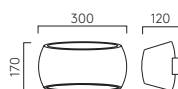

ARIA 300



ARIA 370



CAN BE PAINTED
Peut être peint / kann lackiert
werden / Può essere verniciato

▼ LAMP EXCLUDED, SEE PAGE 685 / La lampe exclu, voir
page 685 / La lampadina esclusi a pagina 685 / Das
Leuchtmittel ist ausgeschlossen, sie auf Seite 685.





KYO (1301001)



OVARO (1123001)



KYO

	LAMP	WATT	CLASS	
C 1301001	E27 LED ▼	12W max		✓

OVARO

	LAMP	WATT	CLASS	
C 1123001	E27 LED ▼	12W max		✓

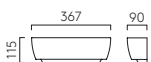

KYO



OVARO



CAN BE PAINTED
Peut être peint / kann lackiert
werden / Può essere verniciato

▼ LAMP EXCLUDED, SEE PAGE 685 / La lampe exclu, voir
page 685 / La lampadina esclusi a pagina 685 / Das
Leuchtmittel ist ausgeschlossen, sie auf Seite 685.





GOSFORD 340 (1383001)



GOSFORD

		LAMP	WATT	CLASS	
340	1383001	E27 LED▼	12W max		✓
460	1383002	E27 LED▼	12W max		✓

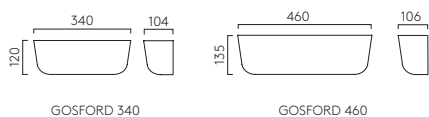

CAN BE PAINTED
 Peut être peint / kann lackiert
 werden / Può essere verniciato

▼ LAMP EXCLUDED, SEE PAGE 685 / La lampe exclu, voir page 685 / La lampadina esclusi a pagina 685 / Das Leuchtmittel ist ausgeschlossen, sie auf Seite 685.





MILO 400 (1299002)



MILO

		LAMP	WATT	CLASS	
300	1299001	E27 LED▼	12W max		✓
400	1299002	E27 LED▼	12W max		✓

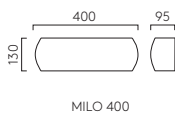
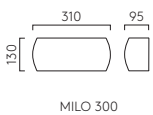

CAN BE PAINTED
Peut être peint / kann lackiert
werden / Può essere verniciato

▼ LAMP EXCLUDED, SEE PAGE 685 / La lampe exclu, voir
page 685 / La lampadina esclusi a pagina 685 / Das
Leuchtmittel ist ausgeschlossen, sie auf Seite 685.





AMALFI 315 (1079001)



AMALFI

		LAMP	WATT	CLASS	
315	1079001	E27 LED ▼	12W max		✓
380	1079004	E27 LED ▼	12W max		✓

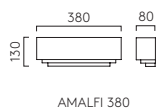
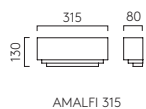

CAN BE PAINTED
Peut être peint / kann lackiert
werden / Può essere verniciato

▼ LAMP EXCLUDED, SEE PAGE 685 / La lampe exclu, voir
page 685 / La lampadina esclusi a pagina 685 / Das
Leuchtmittel ist ausgeschlossen, sie auf Seite 685.

LED





S-LIGHT (1213001)



D-LIGHT

	LAMP	WATT	INPUT	K	CRI	Lm	CLASS	
MW 1208001	Integral LED	4.66W	Mains 230V	3000	85	213	⊕	✓

S-LIGHT

	LAMP	WATT	CLASS	
P 1213001	E14 LED	7W max	⊕	✓

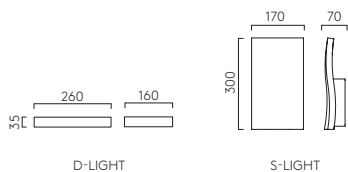

S-LIGHT: CAN BE PAINTED
Peut être peint / kann lackiert
werden / Può essere verniciato

▼ LAMP EXCLUDED, SEE PAGE 685 / La lampe exclu, voir page 685 / La lampadina esclusi a pagina 685 / Das Leuchtmittel ist ausgeschlossen, sie auf Seite 685.

LED





EDGE 560D (1352006)



EDGE

		LAMP	WATT	INPUT	K	CRI	Lm	CLASS		
560	1352001	Integral LED	15.5W	700mA CC▼	3000	80	479		✓	✓
560	1352004	Integral LED	14.7W	700mA CC▼	2700	80	426		✓	-
560D	1352006	Integral LED	14.7W	Mains 230V	2700	80	426		-	-

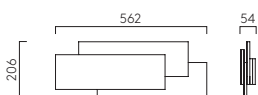

EDGE 560/560D

▼ THE EDGE 560 SHOULD BE ORDERED WITH ONE OF THE FOLLOWING DRIVERS: Le "Edge 560" devrait être commandé avec l'un des drivers suivants / Die Leuchte Edge 560 muss zusammen mit einem der folgenden Betriebsgeräte bestellt werden / Il Edge 560 deve essere ordinato con uno dei seguenti driver: **6008016 (1832), 6008020 (1836)**





CYL 200 (1186001)



CYL 260 (1186002)

WG

CYL

		LAMP	WATT	CLASS		
200	1186001	E14 LED▼	2 x 7W max		✓	✓
260	1186002	E27 LED▼	2 x 12W max		✓	✓

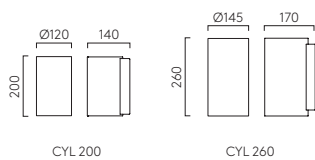

CYL 200

CYL 260

▼ LAMP EXCLUDED, SEE PAGE 685 / La lampe exclu, voir page 685 / La lampadina esclusi a pagina 685 / Das Leuchtmittel ist ausgeschlossen, sie auf Seite 685.

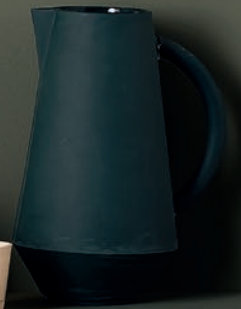



LUGA (1074001)

OBROUND (1072001)

WG

LUGA

	LAMP	WATT	CLASS			
WG 1074001	E14 LED▼	7W max		✓	✓	✓

OBROUND

	LAMP	WATT	CLASS			
WG 1072001	E14 LED▼	7W max		✓	✓	✓

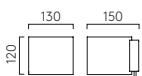

LUGA

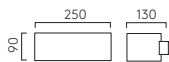

OBROUND

▼ LAMP EXCLUDED, SEE PAGE 685 / La lampe exclu, voir page 685 / La lampadina esclusi a pagina 685 / Das Leuchtmittel ist ausgeschlossen, sie auf Seite 685.





TOKYO (1089001)

WG

TOKYO

	LAMP	WATT	CLASS			
CLASSIC	WG 1089001 E14 LED ▼	7W max		✓	-	✓
	WG 1089004 E27 LED ▼	12W max		✓	-	✓
SWITCHED	WG 1089002 E14 LED ▼	7W max		✓	✓	✓



TOKYO

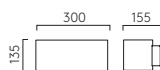

TOKYO CLASSIC



TOKYO SWITCHED

▼ LAMP EXCLUDED, SEE PAGE 685 / La lampe exclu, voir page 685 / La lampadina esclusi a pagina 685 / Das Leuchtmittel ist ausgeschlossen, sie auf Seite 685.

LED

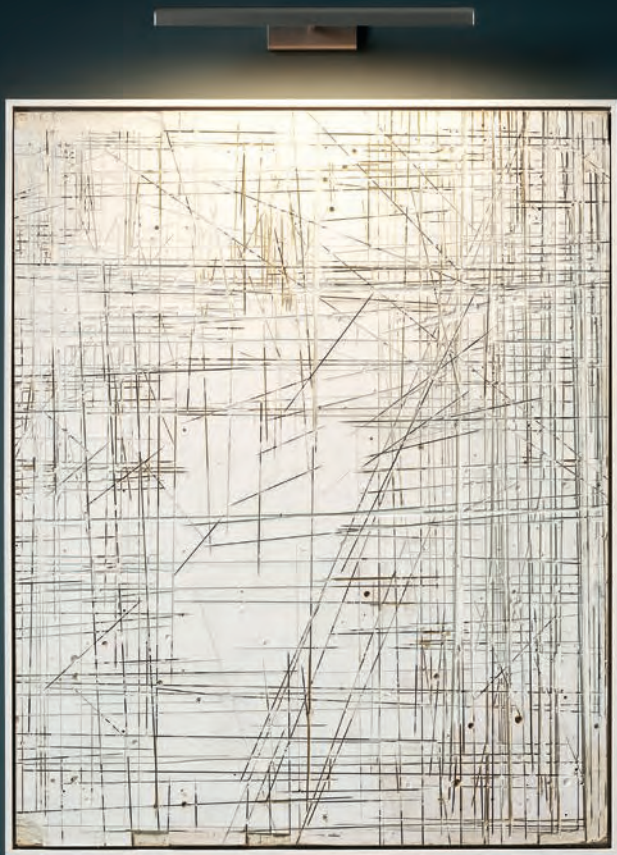

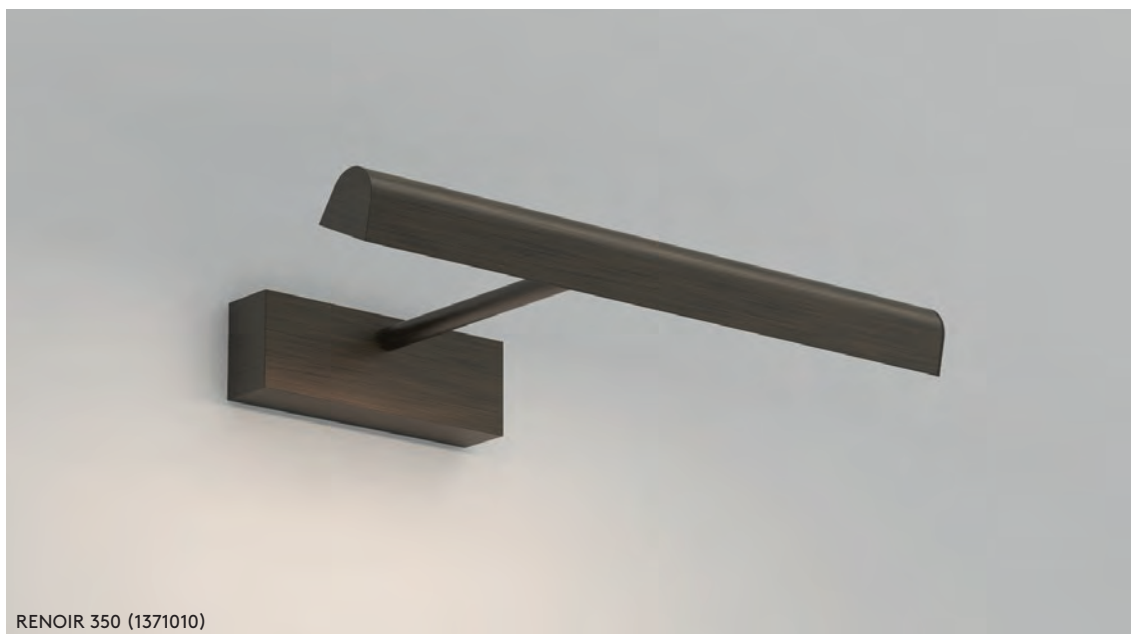

RENOIR 350 (1371010)



NEW

RENOIR

	MN	Br	LAMP	WATT	INPUT	K	CRI	Lm	CLASS	
350	MN 1371009	Br 1371010	Integral LED	3.8W	Mains 230V	2700	80	190	⊕	✓
520	MN 1371012	Br 1371013	Integral LED	4.8W	Mains 230V	2700	80	261	⊕	✓
680	MN 1371015	Br 1371016	Integral LED	6.3W	Mains 230V	2700	80	367	⊕	✓



RENOIR 350

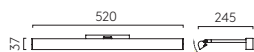

RENOIR 520

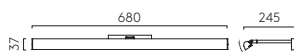

RENOIR 680

LED





MONDRIAN FRAME MOUNTED 300 (1374003)



MONDRIAN FRAME MOUNTED

				LAMP	WATT	INPUT	K	CRI	Lm	CLASS	
300	1374011	1374003		Integral LED	5.1W	12V CV▼	2700	80	112		✓
400	1374007	1374008		Integral LED	6.9W	12V CV▼	2700	80	161		✓
600	1374006	1374004		Integral LED	10.8W	12V CV▼	2700	80	219		✓

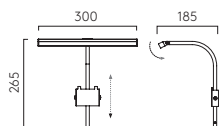

MONDRIAN FRAME MOUNTED 300

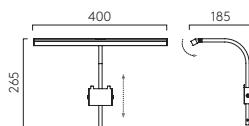

MONDRIAN FRAME MOUNTED 400

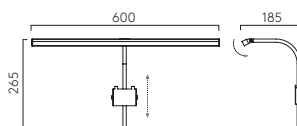

MONDRIAN FRAME MOUNTED 600

CAN BE FRAME-MOUNTED OR WALL MOUNTED
 Peut être monté sur le cadre ou le mur. / Kann auf dem Rahmen oder an der
 Wand montiert werden / Può essere montato a un quadro o a una parete.
 For wall mounted only Mondrian, please refer to next page ▶

▼ DRIVER EXCLUDED, SEE PAGE 683. Driver d'entrée exclu,
 voir page 683. / Driver esclusi a pagina 632. / Das treiber
 ist ausgeschlossen, sie auf Seite 683.





MONDRIAN 600 (1374002)



MONDRIAN

			LAMP	WATT	INPUT	K	CRI	Lm	CLASS
300	MN 1374012	Br 1374005	Integral LED	5.1W	Mains 230V	2700	80	112	⊕
400	MN 1374001	Br 1374009	Integral LED	6.9W	Mains 230V	2700	80	161	⊕
600	MN 1374002	Br 1374019	Integral LED	10.8W	Mains 230V	2700	80	219	⊕



MONDRIAN 300



MONDRIAN 400

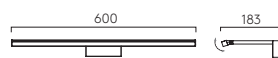

MONDRIAN 600

◀ For frame mounted Mondrian, please refer to previous page.





TEETOO 550 (1161011)



TEETOO 350 (1161007)



TEETOO 550 (1161017)



TEETOO

				LAMP	WATT	CLASS		
350	1161007	1161008	1161016	G4	2 x 20W max		✓	✓
550	1161010	1161011	1161017	G4	4 x 10W max		✓	✓



TEETOO 350

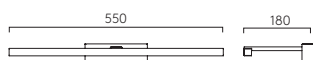

TEETOO 550



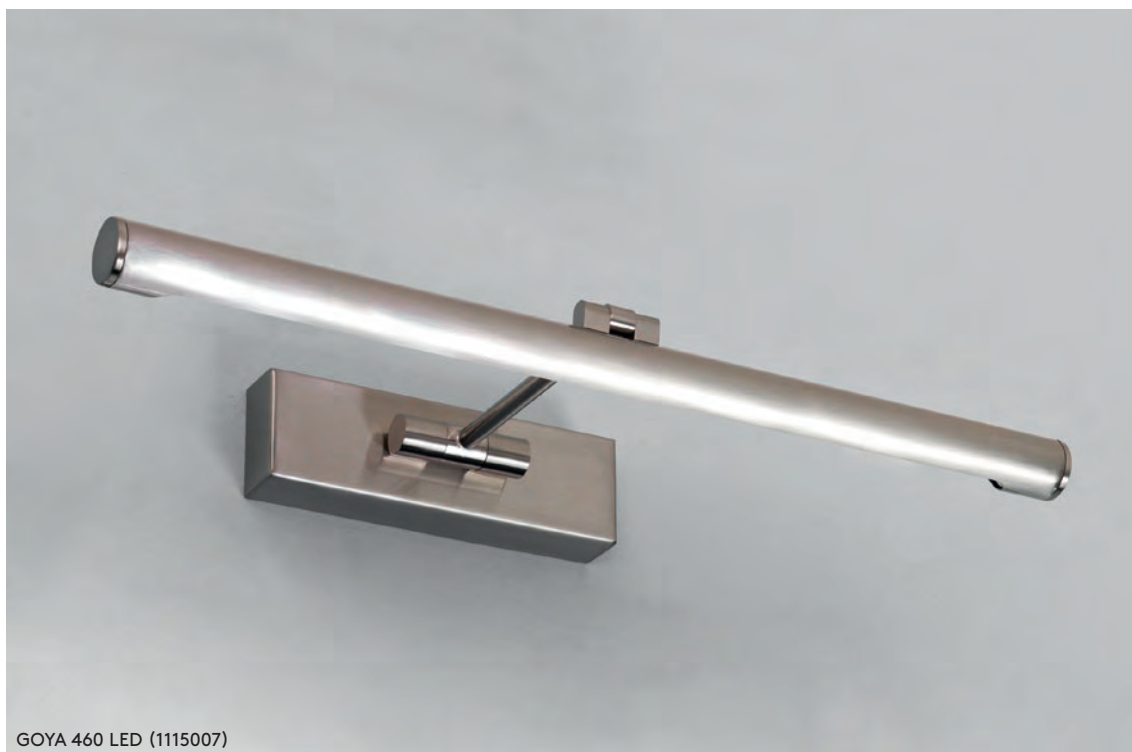



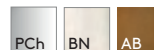









GOYA 460 LED (1115007)



GOYA

				LAMP	WATT	INPUT	K	CRI	Lm	CLASS	
365	 1115001	 1115003		T5	8W	Mains 230V	-	-	-		-
460 LED	 1115007	 1115012	 1115008	Integral LED	7.5W	Mains 230V	2700	80	431		✓
760 LED	 1115009	 1115013	 1115010	Integral LED	10.3W	Mains 230V	2700	80	630		✓

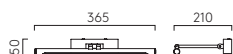

GOYA 365

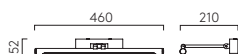

GOYA 460 LED

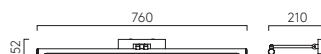

GOYA 760 LED

MARKER

FEUX DE POSITION / MARKLIGHTS / FRECCHE



BORG COLLECTION

1. BORG 54 P. 401
2. BORG 90 P. 401
3. BORG 43 P. 401

4. BORG 55 P. 401
5. BORG TRIMLESS 200 P. 399
6. BORG TRIMLESS 65 P. 399

7. BORG TRIMLESS 98 P. 399
8. BORG TRIMLESS 35 P. 399
9. BORG TRIMLESS MINI P. 399



LED





LEROS TRIMLESS (1342002)



OLYMPUS TRIMLESS (1343002)



LEROS TRIMLESS

	LAMP	WATT	INPUT	K	CRI	Lm	CLASS		
MW 1342002	Integral LED	1.1W	350mA CC▼	2700	80	36		✓	✓

OLYMPUS TRIMLESS

	LAMP	WATT	INPUT	K	CRI	Lm	CLASS		
MW 1343002	Integral LED	2.2W	350mA CC▼	2700	80	35		✓	✓

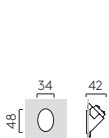

LEROS TRIMLESS

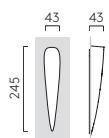

OLYMPUS TRIMLESS

DRIVER MUST BE INSTALLED REMOTELY IN A SERVICEABLE LOCATION.

Le driver doit être installé à distance dans un endroit accessible / Treiber muss remote in einem zu wart Speicherort installiert. / Driver deve essere installato a distanza in un luogo accessibile.

▼ DRIVER EXCLUDED, SEE PAGE 683 / Driver d'entrée exclu, voir page 683 / Driver esclusi a pagina 683 / Das treiber ist ausgeschlossen / Sie auf Seite 683.

LED



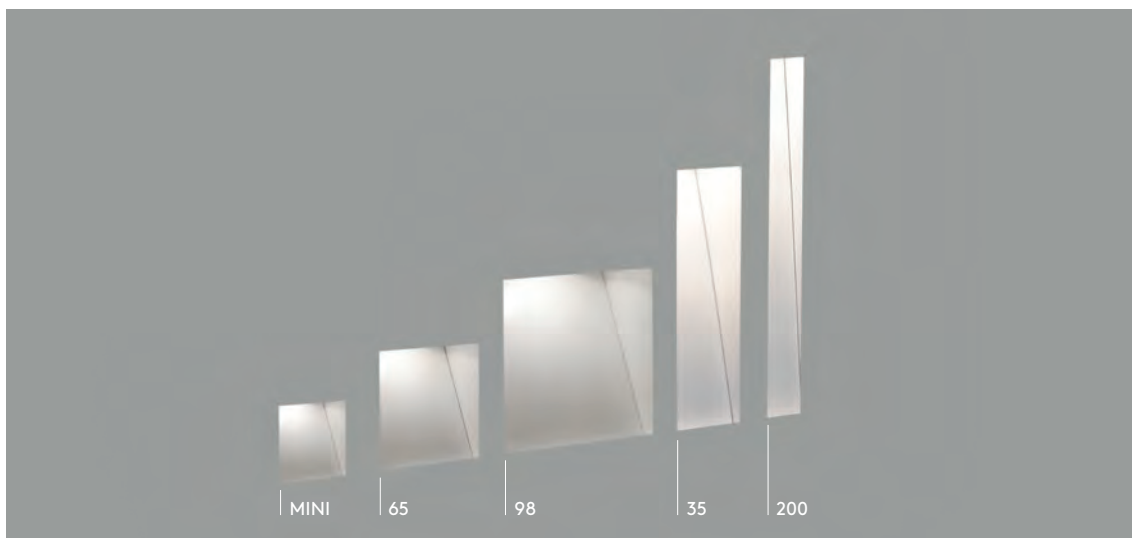

BORG TRIMLESS

		LAMP	WATT	INPUT	K	CRI	Lm	CLASS	🔌
MINI	1212039	Integral LED	1W	350mA CC▼	3000	80	22	⬢	✓
	1212037	Integral LED	1W	350mA CC▼	2700	80	29	⬢	✓
35	1212007	Integral LED	2W	700mA CC▼	3000	80	70	⬢	✓
	1212027	Integral LED	2W	700mA CC▼	2700	80	76	⬢	✓
65	1212008	Integral LED	2W	700mA CC▼	3000	80	80	⬢	✓
	1212028	Integral LED	4.1W	700mA CC▼	2700	80	70	⬢	✓
98	1212041	Integral LED	3.8W	700mA CC▼	3000	80	84	⬢	✓
	1212042	Integral LED	4.1W	700mA CC▼	2700	80	77	⬢	✓
200	1212038	Integral LED	2W	700mA CC▼	3000	80	56	⬢	✓
	1212040	Integral LED	2W	700mA CC▼	2700	80	46	⬢	✓

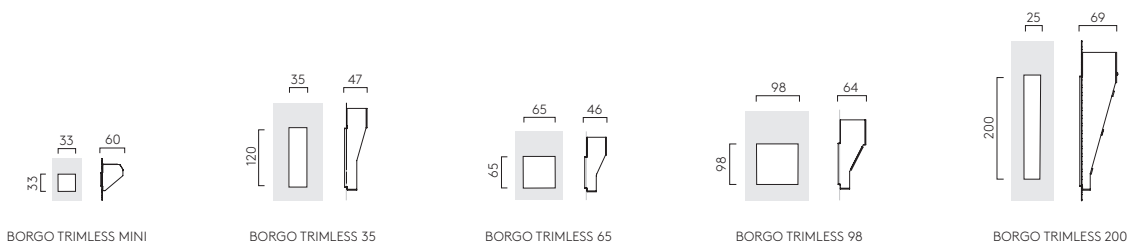

BORG 35, 65, 98 AND 200:
 6008001 AND 6008051 DRIVERS CAN BE ACCESSED AFTER INSTALLATION / Les drivers 6008001 et 6008051 sont accessibles après l'installation / Die Treiber 6008001 und 6008051 sind nach der Montage zugänglich / 6008001 e 6008051 driver sono accessibili dopo l'installazione.



BORG MINI:
 DRIVER MUST BE INSTALLED REMOTELY IN A SERVICEABLE LOCATION. / Le driver doit être installé à distance dans un endroit accessible / Treiber muss remote in einem zu wart Speicherort installiert / Driver deve essere installato a distanza in un luogo accessibile.

▼ DRIVER EXCLUDED, SEE PAGE 683 / Driver d'entrée exclu, voir page 683 / Driver esclusi a pagina 683 / Das treiber ist ausgeschlossen / Sie auf Seite 683.

LED



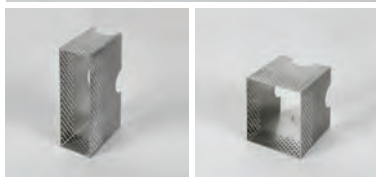
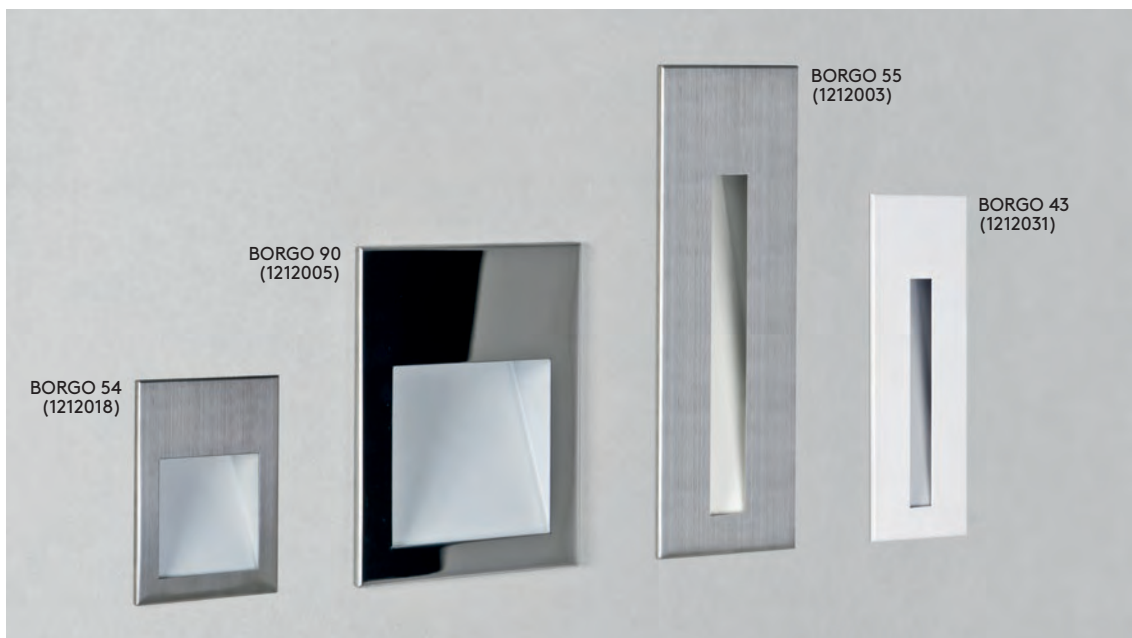

55 WALL BOX
6013001
H:165mm W:51mm D:100mm

90 WALL BOX
6013002
H:108mm W:87mm D:100mm

LED DRIVER ACCESSIBLE AFTER INSTALLATION / Driver LED accessibles après installation / LED-Treiber ist nach der Installation zugänglich / Accesso al driver anche dopo l'installazione

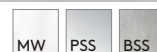

BORGEO

	LAMP	WATT	INPUT	K	CRI	Lm	CLASS	☑	Ⓢ	Ⓜ			
43	PSS 1212015	TW 1212017	BSS 1212016	Integral LED	2.6W	350mA CC▼	3000	80	15	Ⓢ	☑	☑	☑
	PSS 1212029	TW 1212031	BSS 1212030	Integral LED	2.6W	350mA CC▼	2700	80	12	Ⓢ	☑	☑	☑
54	PSS 1212020	TW 1212019	BSS 1212018	Integral LED	2.6W	350mA CC▼	3000	80	30	Ⓢ	☑	☑	☑
	PSS 1212034	TW 1212033	BSS 1212032	Integral LED	2.6W	350mA CC▼	2700	80	30	Ⓢ	☑	☑	☑
55	PSS 1212002	MW 1212001	BSS 1212003	Integral LED	2W	700mA CC▼	3000	80	39	Ⓢ	☑	☑	☑
	PSS 1212022	MW 1212021	BSS 1212023	Integral LED	2W	700mA CC▼	2700	80	40	Ⓢ	☑	☑	☑
90	PSS 1212005	MW 1212004	BSS 1212006	Integral LED	2W	700mA CC▼	3000	80	72	Ⓢ	☑	☑	☑
	PSS 1212025	MW 1212024	BSS 1212026	Integral LED	2W	700mA CC▼	2700	80	68	Ⓢ	☑	☑	☑

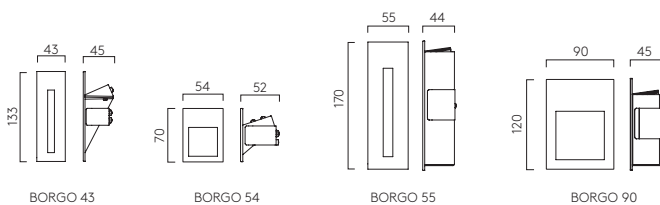

A WALL BOX ACCESSORY IS AVAILABLE FOR INSTALLATION OF THE BORGEO 55 AND 90 INTO BRICK WALLS
 Accessoire mural disponible pour l'installation de la gamme BORGEO dans des murs en brique / Als Zubehör sind Wandkästen erhältlich, die eine Installation der BORGEO Serie in Ziegelwänden ermöglichen. / Un accessorio per le pareti è disponibile per l'installazione del BORGEO in muri di mattoni.

▼ DRIVER EXCLUDED, SEE PAGE 683 / Driver d'entrée exclu, voir page 683 / Driver esclusi a pagina 683 / Das treiber ist ausgeschlossen / Sie auf Seite 683.





TANGO (1175005)

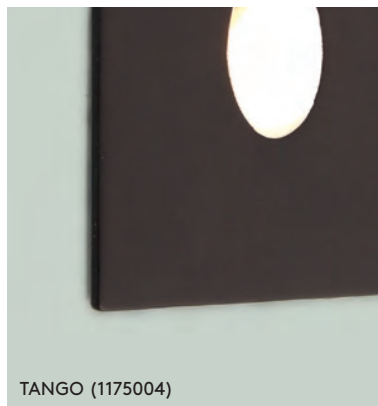

TANGO (1175004)



TANGO (1175002)



TANGO

	LAMP	WATT	INPUT	K	CRI	Lm	CLASS				
BSS 1175002	Integral LED	2.1W	350mA CC▼	3000	80	23	◊	✓	✓		
BSS 1175007	Integral LED	2.6W	350mA CC▼	2700	80	29	◊	✓	✓		
MW 1175001	Integral LED	2.1W	350mA CC▼	3000	80	23	◊	✓	✓		
MW 1175006	Integral LED	2.6W	350mA CC▼	2700	80	29	◊	✓	✓		
PSS 1175005											
PSS 1175010											
TB 1175004											
TB 1175009											

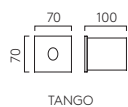

TANGO

▼ DRIVER EXCLUDED, SEE PAGE 683 / Driver d'entrée exclu, voir page 683 / Driver esclusi a pagina 683 / Das treiber ist ausgeschlossen / Sie auf Seite 683.



TABLE & FLOOR

LAMPADAIRES TABLE ET SOL • TISCH-UND STEHLEUCHTEN • LAMPADE DA TAVOLO E DA TERRA



MARTELLO 180
P. 407



MARTELLO 240
P. 407



ASCOLI DESK
P. 409



ASCOLI FLOOR
P. 409



ENNA DESK
P. 413



ENNA FLOOR
P. 415



ATELIER CLAMP
P. 417



ATELIER DESK
P. 417



ATELIER FLOOR
P. 419



JOEL TABLE
P. 420



JOEL GRANDE TABLE
P. 421



JOEL FLOOR
P. 423



NEW
TELEGRAPH TABLE
P. 425



NEW
TELEGRAPH FLOOR
P. 425



RAVELLO TABLE
P. 427



RAVELLO FLOOR
P. 429



AZUMI TABLE
P. 430



AZUMI FLOOR
P. 431



PARK LANE TABLE
P. 432



PARK LANE FLOOR
P. 433



NEW
CUT
P. 435



LIMINA
P. 437



MARASINO
P. 437





MARTELLO 180 (1395001)



MARTELLO 240 (1395002)



MARTELLO

		LAMP	WATT	CLASS	
180	1395001	E14 LED ▼	5W max		✓
240	1395002	E27 LED ▼	7W max		✓

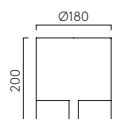

MARTELLO 180

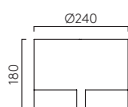

MARTELLO 240

▼ LAMP EXCLUDED, SEE PAGE 685 / La lampe exclu, voir page 685 / La lampadina esclusi a pagina 685 / Das Leuchtmittel ist ausgeschlossen, sie auf Seite 685.





ASCOLI DESK (1286024)



ASCOLI DESK (1286017)



ASCOLI DESK

	LAMP	WATT	CLASS	
MW 1286016	GU10 LED	6W max	<input type="checkbox"/>	<input checked="" type="checkbox"/>
MN 1286017				
Br 1286024				

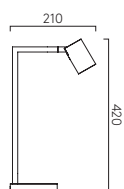

ASCOLI DESK

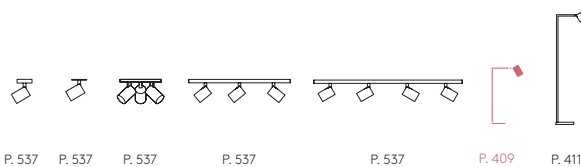

▼ LAMP EXCLUDED, SEE PAGE 685 / La lampe exclu, voir page 685 / La lampadina esclusi a pagina 685 / Das Leuchtmittel ist ausgeschlossen, sie auf Seite 685.





ASCOLI FLOOR (1286019)



ASCOLI FLOOR (1286025)

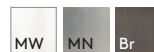

ASCOLI FLOOR

	LAMP	WATT	CLASS	
MW 1286018	GU10 LED	6W max		✓
MN 1286019				
Br 1286025				

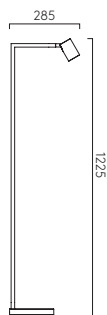

ASCOLI FLOOR

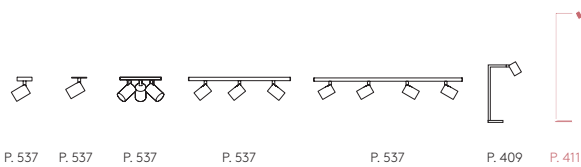

▼ LAMP EXCLUDED, SEE PAGE 685 / La lampe exclu, voir page 685 / La lampadina esclusi a pagina 685 / Das Leuchtmittel ist ausgeschlossen, sie auf Seite 685.

LED





ENNA DESK (1058006)



ENNA DESK (1058057)



ENNA DESK

	LAMP	WATT	INPUT	K	CRI	Lm	CLASS
MW 1058005 MB 1058006 MN 1058057 MG 1058106	Integral LED	4.5W	Mains 230V	2700	80	124	<input type="checkbox"/> <input checked="" type="checkbox"/>

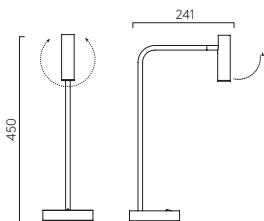

ENNA DESK

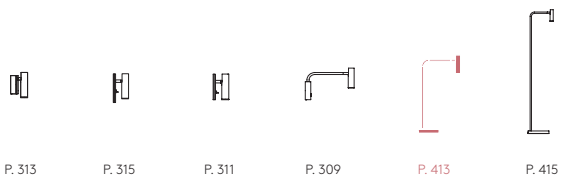

LED





ENNA FLOOR (1058002)



ENNA FLOOR (1058003)



ENNA FLOOR

	LAMP	WATT	INPUT	K	CRI	Lm	CLASS	
MW 1058002 MB 1058003 MN 1058058 MG 1058107	Integral LED	4.5W	Mains 230V	2700	80	124	<input type="checkbox"/>	<input checked="" type="checkbox"/>

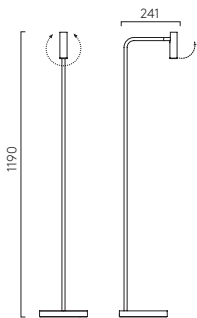

ENNA FLOOR

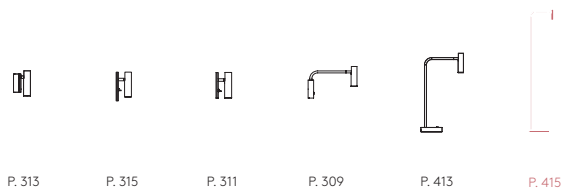

P. 313

P. 315

P. 311

P. 309

P. 413

P. 415





ATELIER ARM ASSEMBLY + DESK (1224003 + 1224006)



ATELIER ARM ASSEMBLY + CLAMP (1224001 + 1224010)



ATELIER

	PA	MW	MB	LAMP	WATT	CLASS	I
ARM ASSEMBLY	1224001	1224002	1224003	E27 LED ▼	12W max		✓
CLAMP	1224010			-	-	-	-
DESK BASE	1224004	1224005	1224006	-	-	-	-

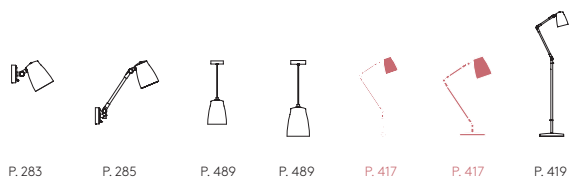
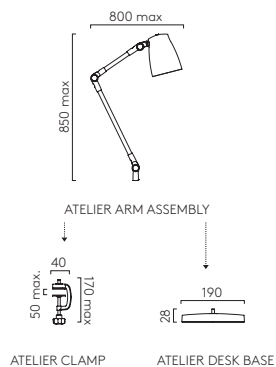

ARM ASSEMBLY FOR USE WITH: En combinaison avec / Zur Verwendung mit / Da installare con: Atelier Clamp (1224010), Atelier Desk Base (1224004,1224005,1224006), Atelier Floor Base (1224007,1224008,1224009).

▼ LAMP EXCLUDED, SEE PAGE 685 / La lampe exclu, voir page 685 / La lampadina esclusi a pagina 685 / Das Leuchtmittel ist ausgeschlossen, sie auf Seite 685.





ATELIER ARM ASSEMBLY + FLOOR BASE (1224001 + 1224007)



ATELIER ARM ASSEMBLY + FLOOR BASE (1224002 + 1224008)



ATELIER

	PA	MW	MB	LAMP	WATT	CLASS	I
ARM ASSEMBLY	1224001	1224002	1224003	E27 LED▼	12W max		✓
FLOOR BASE	1224007	1224008	1224009	-	-	-	-

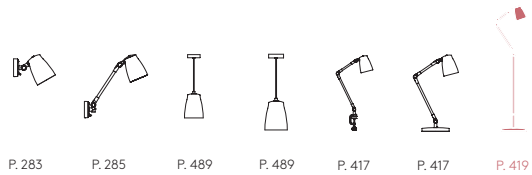
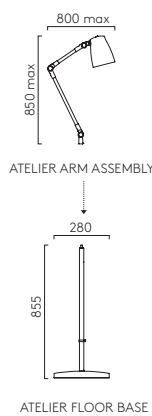

Floor Base for use with / En combinaison avec / Zur Verwendung mit / Da installare con: Atelier Arm Assembly (1224001,1224002,1224003).

▼ LAMP EXCLUDED, SEE PAGE 685 / La lampe exclu, voir page 685 / La lampadina esclusi a pagina 685 / Das Leuchtmittel ist ausgeschlossen, sie auf Seite 685.



JOEL TABLE (1223002)



JOEL TABLE (1223003)



JOEL TABLE

	LAMP	WATT	CLASS	
MB 1223002	E27 LED▼	12W max	<input type="checkbox"/>	<input checked="" type="checkbox"/>
Cr 1223003			<input type="checkbox"/>	<input checked="" type="checkbox"/>

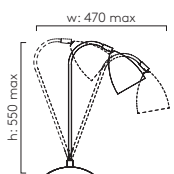

JOEL TABLE

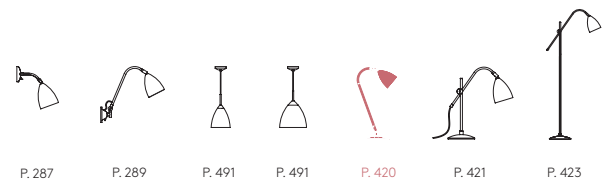

▼ LAMP EXCLUDED, SEE PAGE 685 / La lampe exclu, voir page 685 / La lampadina esclusi a pagina 685 / Das Leuchtmittel ist ausgeschlossen, sie auf Seite 685.



JOEL GRANDE TABLE (1223010)

MB Cr

JOEL GRANDE TABLE

		LAMP	WATT	CLASS	I
MB 1223011	Cr 1223010	E27 LED▼	12W max	□	✓

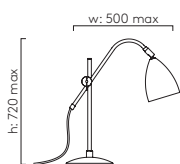

JOEL GRANDE TABLE

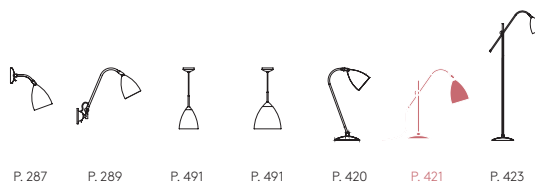

▼ LAMP EXCLUDED, SEE PAGE 685 / La lampe exclu, voir page 685 / La lampadina esclusi a pagina 685 / Das Leuchtmittel ist ausgeschlossen, sie auf Seite 685.





JOEL FLOOR (1223006)



JOEL FLOOR (1223005)

MB Cr

JOEL FLOOR

	LAMP	WATT	CLASS	
MB 1223005	E27 LED ▼	12W max	<input type="checkbox"/>	<input checked="" type="checkbox"/>
Cr 1223006				

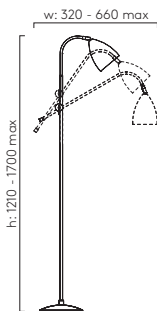

JOEL FLOOR

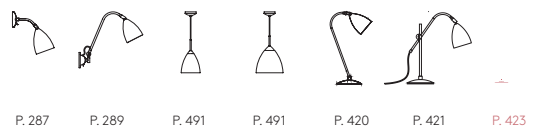

▼ LAMP EXCLUDED, SEE PAGE 685 / La lampe exclu, voir page 685 / La lampadina esclusi a pagina 685 / Das Leuchtmittel ist ausgeschlossen, sie auf Seite 685.





TELEGRAPH TABLE (1404006)



TELEGRAPH FLOOR (1404007)



NEW

TELEGRAPH

SHADE EXCLUDED

	MB	MN	Br	LAMP	WATT	CLASS	
TABLE	1404004	1404005	1404006	E27 LED ▼	12W max		✓
FLOOR	1404007	1404008	1404009	E27 LED ▼	12W max		✓

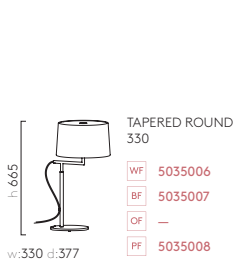

TELEGRAPH TABLE

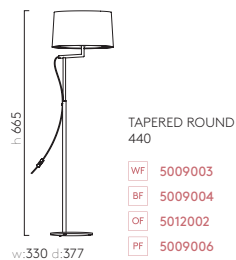

TELEGRAPH FLOOR

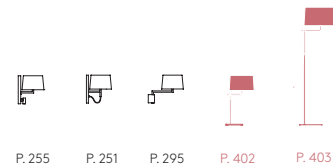

P. 687: SPECIAL SHADE COLOURS
Couleurs spéciales / Sonderfarben / Colori speciali

▼ LAMP EXCLUDED, SEE PAGE 685 / La lampe exclu, voir page 685 / La lampadina esclusi a pagina 685 / Das Leuchtmittel ist ausgeschlossen, sie auf Seite 685.





RAVELLO TABLE (1222007 + 5016007)



RAVELLO TABLE (1222008 + 5030009)



RAVELLO TABLE

SHADE EXCLUDED

			LAMP	WATT	CLASS				
PCh	1222007	MN	1222008	Br	1222009	E27 LED	12W max	<input type="checkbox"/>	<input checked="" type="checkbox"/>

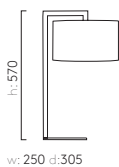

DRUM 250

- WF 5016007
- BF 5016008
- OF 5016009
- PF 5016019

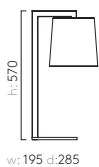

TAPERED SQUARE 195

- WF 5030008
- BF 5030007
- OF 5030009
- PF 5030010



P. 251



P. 301



P. 427



P. 429

P. 687: SPECIAL SHADE COLOURS
Couleurs spéciales / Sonderfarben / Colori speciali

▼ LAMP EXCLUDED, SEE PAGE 685 / La lampe exclu, voir page 685 / La lampadina esclusi a pagina 685 / Das Leuchtmittel ist ausgeschlossen, sie auf Seite 685.





RAVELLO FLOOR (1222001 + 5030013)



RAVELLO FLOOR (1222003 + 5016004)



RAVELLO FLOOR

SHADE EXCLUDED

			LAMP	WATT	CLASS	
PCh 1222001	MN 1222002	Br 1222003	E27 LED ▼	12W max		<input checked="" type="checkbox"/>

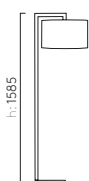

w: 420 d: 485

DRUM 420

- WF** 5016004
- BF** 5016005
- OF** 5016006
- PF** —



w: 300 d: 425

TAPERED SQUARE 300

- WF** 5030012
- BF** 5030011
- OF** 5030013
- PF** 5030014



P. 251



P. 301



P. 427



P. 429

P. 687: SPECIAL SHADE COLOURS
Couleurs spéciales / Sonderfarben / Colori speciali

▼ LAMP EXCLUDED, SEE PAGE 685 / La lampe exclu, voir page 685 / La lampadina esclusi a pagina 685 / Das Leuchtmittel ist ausgeschlossen, sie auf Seite 685.



AZUMI TABLE (1142022 + 5003001)



AZUMI TABLE

SHADE EXCLUDED

			LAMP	WATT	CLASS				
PN	1142018	MN	1142022	Br	1142045	E27 LED	12W max	☐	✓

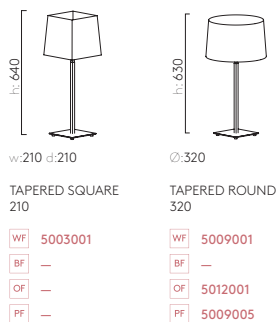

P. 687: SPECIAL SHADE COLOURS Couleurs spéciales / Sonderfarben / Colori speciali

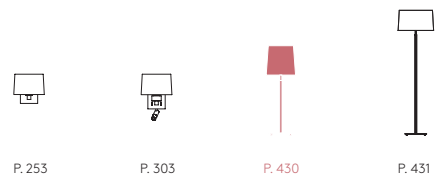

▼ LAMP EXCLUDED, SEE PAGE 685 / La lampe exclu, voir page 685 / La lampadina esclusi a pagina 685 / Das Leuchtmittel ist ausgeschlossen, sie auf Seite 685.



AZUMI TABLE (1142022 + 5003001) + AZUMI FLOOR (1142023 + 5003003)



AZUMI FLOOR

SHADE EXCLUDED

	LAMP	WATT	CLASS	
PN 1142020	E27 LED	12W max	<input type="checkbox"/>	<input checked="" type="checkbox"/>

MN 1142023 Br 1142046

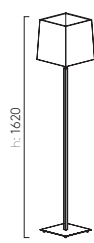
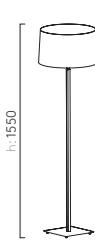
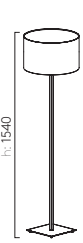
 h: 1620 w: 300 d: 300 AZUMI TAPERED SQUARE 300	 h: 1550 Ø: 440 TAPERED ROUND 440	 h: 1540 Ø: 420 DRUM 420
WF 5003003	WF 5009003	WF 5016004
BF -	BF 5009004	BF 5016005
OF -	OF 5012002	OF 5016006
PF -	PF 5009006	PF -

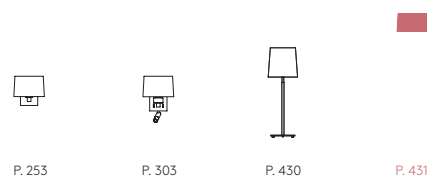

▼ LAMP EXCLUDED, SEE PAGE 685 / La lampe exclu, voir page 685 / La lampadina esclusi a pagina 685 / Das Leuchtmittel ist ausgeschlossen, sie auf Seite 685.

P. 687: SPECIAL SHADE COLOURS Couleurs spéciales / Sonderfarben / Colori speciali



PARK LANE TABLE (1080013 + 5001001) THE HALCYON HOTEL, BATH UK



PARK LANE TABLE (1080013 + 5001007)



PARK LANE TABLE

SHADE EXCLUDED

	LAMP	WATT	CLASS	
PCh 1080013 MN 1080016 Br 1080046	E27 LED ▼	12W max		

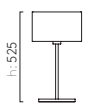

w:285 d:170

RECTANGLE 285

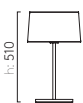

∅:300

TAPERED OVAL*

- WF 5001001
- BF 5001003
- OF 5001007
- PF 5001017

- WF 5034001
- BF 5034002
- OF 5034003
- PF 5034004

P. 687: SPECIAL SHADE COLOURS
Couleurs spéciales / Sonderfarben / Colori speciali

* TO BE USED WITH LED/CFL LAMP ONLY / Pour utilisation avec lampe LED/CFL seulement. / nur mit Kompaktleuchtstofflampe / LED verwenden / Solo per l'uso con lampade a LED/CFL

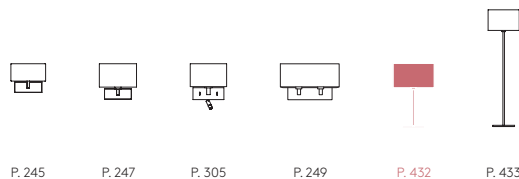

▼ LAMP EXCLUDED, SEE PAGE 685 / La lampe exclu, voir page 685 / La lampadina esclusi a pagina 685 / Das Leuchtmittel ist ausgeschlossen, sie auf Seite 685.



PARK LANE FLOOR (1080047 + 5001002)



PARK LANE FLOOR (1080017 + 5001002)



PARK LANE FLOOR

SHADE EXCLUDED

	LAMP	WATT	CLASS	
PCh 1080015 MN 1080017 Br 1080047	E27 LED ▼	12W max		<input checked="" type="checkbox"/>

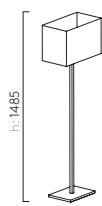

h:1485

RECTANGLE 400

- WF 5001002
- BF —
- OF —
- PF 5001030

w:400 d:225



P. 243



P. 245



P. 281



P. 249



P. 432



P. 433

P. 687: SPECIAL SHADE COLOURS
Couleurs spéciales / Sonderfarben / Colori speciali

▼ LAMP EXCLUDED, SEE PAGE 685 / La lampe exclu, voir page 685 / La lampadina esclusi a pagina 685 / Das Leuchtmittel ist ausgeschlossen, sie auf Seite 685.



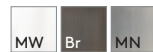

NEW CUT

			LAMP	WATT	CLASS				
MW	1412001	Br	1412002	MN	1412003	GU10 LED	6W max	□	✓

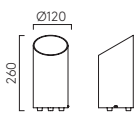

▼ LAMP EXCLUDED, SEE PAGE 685 / La lampe exclu, voir page 685 / La lampadina esclusi a pagina 685 / Das Leuchtmittel ist ausgeschlossen, sie auf Seite 685.





MARASINO (1218001)



LIMINA (1221001)



MARASINO

	LAMP	WATT	CLASS	
1218001	GU10 LED▼	6W max		✓

LIMINA

	LAMP	WATT	CLASS	
1221001	GU10 LED▼	6W max		✓

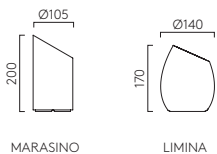

▼ LAMP EXCLUDED, SEE PAGE 685 / La lampe exclu, voir page 685 / La lampadina esclusi a pagina 685 / Das Leuchtmittel ist ausgeschlossen, sie auf Seite 685.



CEILING

LUMINAIRES DE PLAFOND • DECKENLEUCHTEN • LAMPADE DA SOFFITTO



● PLEAT 370
P. 441



SEMI-FLUSH UNIT
P. 443



BEVEL ROUND
P. 445



BEVEL SQUARE
P. 445



● ZERO ROUND
P. 447



● ZERO SQUARE
P. 447



● **NEW** MASHIKO SQUARE
P. 449



● MASHIKO ROUND
P. 451



● **NEW** TAKETA LED
P. 453



● MALLON
P. 455



● ALTEA
P. 457



● DAKOTA
P. 459



● OSAKA
P. 461



DENIA
P. 461



● SABINA 280
P. 463



SABINA 170
P. 463



SABINA SQUARE
P. 463



● KIWI CEILING
P. 465



ZEPP0 CEILING
P. 467



CASTIRO 225
P. 468



● MASSA
P. 469



AREZZO CEILING
P. 471



SYROS
P. 473

LED





PLEAT 370 + MASSA 300 LED (5013008 + 1337004)



PLEAT 370

PLEAT 370 SHADE WF 5013007 BF 5013008

Requires/nécessite/erfordert/necessita: **MASSA 300 LED 1337004 (7995)**

	LAMP	WATT	INPUT	K	CRI	Lm	IP	CLASS
MASSA 300 LED MW 1337004	Integral LED	16.4W	Mains 230V	2700	80	1311	44	



P. 687: SPECIAL SHADE COLOURS
Couleurs spéciales / Sonderfarben / Colori speciali





SEMI FLUSH UNIT

SHADE EXCLUDED

				LAMP	WATT	CLASS	
PCh 1362001	MN 1362002	Br 1362009	TW 1362004	E27 LED ▼	12W max	⊕	✓

h: 250 ∅:420	h: 250 ∅:500	h: 230 ∅:400	h: 230 ∅:500	h: 230 ∅:400
DRUM 420	DRUM 500	DRUM 400 PLEATED	DRUM 500 PLEATED	TAPERED ROUND 400 PLEATED
WF 5016004	WF 5016010	WF 5016013	WF 5016016	WF 5002009
BF 5016005	BF 5016011	BF 5016014	BF 5016017	BF —
OF 5016006	OF 5016012	OF —	OF —	OF —
PF —	PF —	PF 5016015	PF 5016018	PF 5002010

P. 687: SPECIAL SHADE COLOURS
Couleurs spéciales / Sonderfarben / Colori speciali

▼ LAMP EXCLUDED, SEE PAGE 685 / La lampe exclu, voir page 685 / La lampadina esclusi a pagina 685 / Das Leuchtmittel ist ausgeschlossen, sie auf Seite 685.





BEVEL SQUARE 400 (5021004 + 1296001)



BEVEL

			CEILING PLATE EXCL.	LAMP	WATT	CLASS	
ROUND 450	WF 5021003	OF 5021011	3-way plate - 1296001	E27 LED ▼	12W max		✓
ROUND 600	WF 5021001	OF 5021009	4-way plate - 1296002	E27 LED ▼	12W max		✓
SQUARE 400	WF 5021004	OF 5021012	3-way plate - 1296001	E27 LED ▼	12W max		✓
SQUARE 550	WF 5021002	OF 5021010	4-way plate - 1296002	E27 LED ▼	12W max		✓

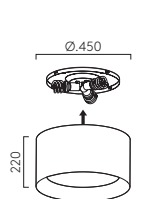

BEVEL ROUND 450

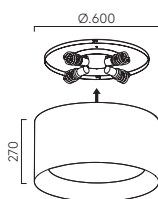

BEVEL ROUND 600

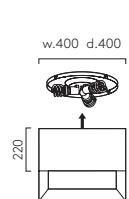

BEVEL SQUARE 400

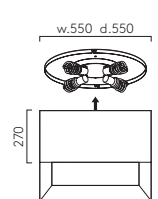

BEVEL SQUARE 550

▼ LAMP EXCLUDED, SEE PAGE 685 / La lampe exclu, voir page 685 / La lampadina esclusi a pagina 685 / Das Leuchtmittel ist ausgeschlossen, sie auf Seite 685.

LED





ZERO

		LAMP	WATT	INPUT	K	CRI	Lm	CLASS
ROUND	1382002	Integral LED	16.6W	Mains 230V	2700	80	810	
SQUARE	1382001	Integral LED	15.4W	Mains 230V	2700	80	806	

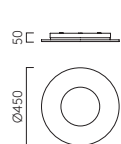

ZERO ROUND

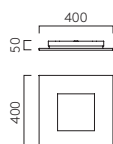

ZERO SQUARE

LED





MASHIKO 400 (1121010)



MASHIKO 200 (1121009)



MASHIKO SQUARE

			LAMP	WATT	INPUT	K	CRI	Lm	IP	CLASS			
	200	PCh 1121009 Br 1121056	E27 LED▼	12W max	-	-	-	-	44		✓	✓	-
	300 LED	PCh 1121040 Br 1121044 MN 1121071	Integral LED	16W	Mains 230V	2700	80	981	44		-	✓	✓
	CLASSIC 300	PCh 1121005	E27 LED▼	2 x 12W max	-	-	-	-	44		✓	✓	-
	400	PCh 1121010 Br 1121013	E27 LED▼	4 x 12W max	-	-	-	-	44		✓	✓	-
NEW	400 LED	PCh 1121067 Br 1121069	Integral LED	27.4W	Mains 230V	3000	80	2458	44		-	✓	✓

EMERGENCY

NEW	400 LED basic	PCh 1121075 Br 1121076	Integral LED	25.6W	Mains 230V	3000	80	2458	44		-	✓	✓
NEW	400 LED selftest	PCh 1121072 Br 1121074	Integral LED	25.6W	Mains 230V	3000	80	2458	44		-	✓	✓

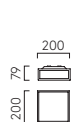

MASHIKO 200

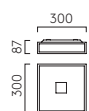

MASHIKO 300/300 LED
/ 300 CLASSIC

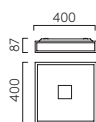

MASHIKO 400

▼ LAMP EXCLUDED, SEE PAGE 685 / La lampe exclu, voir page 685 / La lampadina esclusi a pagina 685 / Das Leuchtmittel ist ausgeschlossen, sie auf Seite 685.

LED





MASHIKO ROUND 230 (1121021)



MASHIKO ROUND 300 LED (1121045)



MASHIKO ROUND

			LAMP	WATT	INPUT	K	CRI	Lm	IP	CLASS		
230	1121021		E27 LED▼	12W max	-	-	-	-	44		✓	✓
300 LED	1121041	1121045	Integral LED	16W	Mains 230V	2700	80	996	44		✓	✓
300	1121017	1121043	E27 LED▼	12W max	-	-	-	-	44		✓	✓
400	1121026		E27 LED▼	12W max	-	-	-	-	44		✓	✓

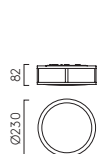

MASHIKO 230

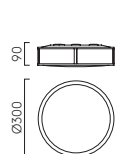

MASHIKO 300/300 LED

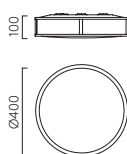

MASHIKO 400

▼ LAMP EXCLUDED, SEE PAGE 685 / La lampe exclu, voir page 685 / La lampadina esclusi a pagina 685 / Das Leuchtmittel ist ausgeschlossen, sie auf Seite 685.

LED





TAKETA LED (1169010)

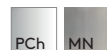

TAKETA

			LAMP	WATT	INPUT	K	CRI	Lm	IP	CLASS		
	300 LED	1169010	Integral LED	16.3W	Mains 230V	2700	80	834	44		✓	
	300 LED	1169007	Integral LED	17.8W	Mains 230V	3000	80	820	44		✓	
NEW	400 LED	1169014 1169015	Integral LED	23.4W	Mains 230V	3000	80	2172	44		✓	✓

EMERGENCY

NEW	400 LED basic	1169018 1169019	Integral LED	23.4W	Mains 230V	3000	80	2172	44		✓	✓
NEW	400 LED selftest	1169016 1169017	Integral LED	23.4W	Mains 230V	3000	80	2172	44		✓	✓

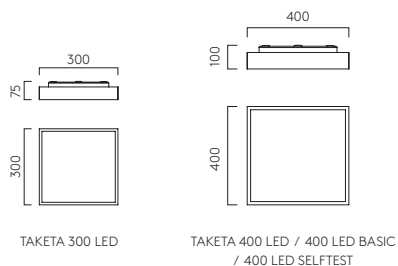

LED





MALLON LED (1125004)



MALLON LED (1125006)



MALLON LED

	LAMP	WATT	INPUT	K	CRI	Lm	IP	CLASS		
PCh 1125004										
MN 1125005										
Br 1125006										
	Integral LED	16W	Mains 230V	2700	80	810	44			

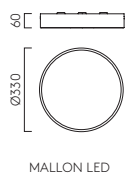

LED





ALTEA 150 (1133004)



ALTEA 300 (1133002)



ALTEA

		LAMP	WATT	INPUT	K	CRI	Lm	IP	CLASS		
150	1133004	Integral LED	8.1W	Mains 230V	2700	80	415	44		-	✓
300 LED	1133007	Integral LED	15.6W max	Mains 230V	2700	80	673	44		-	✓
300	1133002	E27 LED▼	12W max	-	-	-	-	44		✓	✓

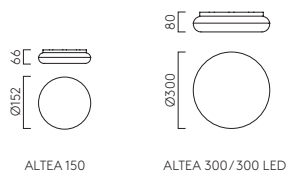

▼ LAMP EXCLUDED, SEE PAGE 685 / La lampe exclu, voir page 685 / La lampadina esclusi a pagina 685 / Das Leuchtmittel ist ausgeschlossen, sie auf Seite 685.

LED





DAKOTA 180 (1129006)

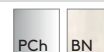

DAKOTA

		LAMP	WATT	INPUT	K	CRI	Lm	IP	CLASS			
180	1129006	E14 LED▼	7W	-	-	-	-	44		✓	✓	-
300	1129001 1129005	E27 LED▼	12W max	-	-	-	-	44		✓	✓	-
300 LED	1129007	Integral LED	16.1W max	Mains 230V	2700	80	748	44		-	✓	-



DAKOTA 180

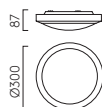

DAKOTA 300/300 LED

▼ LAMP EXCLUDED, SEE PAGE 685 / La lampe exclu, voir page 685 / La lampadina esclusi a pagina 685 / Das Leuchtmittel ist ausgeschlossen, sie auf Seite 685.

LED





OSAKA 350 LED (1061006)



DENIA (1134001)



OSAKA

	LAMP	WATT	INPUT	K	CRI	Lm	IP	CLASS	
LED	PCh 1061009	Integral LED	16W	Mains 230V	2700	80	1048	44	<input type="checkbox"/>
350 LED	PCh 1061006	Integral LED	22.4W	Mains 230V	3000	80	1315	44	<input type="checkbox"/>

DENIA

	LAMP	WATT	CLASS		
PCh 1134001	E14 LED	2 x 7W max	<input type="checkbox"/>	✓	✓

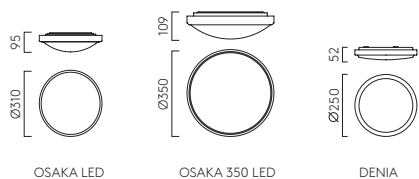

▼ LAMP EXCLUDED, SEE PAGE 685 / La lampe exclu, voir page 685 / La lampadina esclusi a pagina 685 / Das Leuchtmittel ist ausgeschlossen, sie auf Seite 685.

LED





PCh

SABINA

		LAMP	WATT	INPUT	K	CRI	Lm	IP	CLASS		
170	1292001	E27 LED▼	7W	-	-	-	-	44		✓	✓
280	1292003	E27 LED▼	12W max	-	-	-	-	44		✓	✓
280 LED	1292007	Integral LED	16W max	Mains 230V	2700	80	931	44		-	✓
SQUARE	1292002	E27 LED▼	12W max	-	-	-	-	44		✓	✓

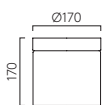

SABINA 170

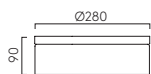

SABINA 280/280 LED

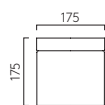

SABINA SQUARE

▼ LAMP EXCLUDED, SEE PAGE 685 / La lampe exclu, voir page 685 / La lampadina esclusi a pagina 685 / Das Leuchtmittel ist ausgeschlossen, sie auf Seite 685.

LED





KIWI CEILING (1390002)



KIWI CEILING

	LAMP	WATT	INPUT	K	CRI	Lm	IP	CLASS	Ⓢ
PCh 1390002	Integral LED	7.3W	Mains 230V	2700	80	555	44	□	✓



KIWI CEILING





ZEPP0 CEILING (1176001)



ZEPP0 CEILING

	LAMP	WATT	CLASS		
PCh 1176001	E27 LED	12W max		✓	✓

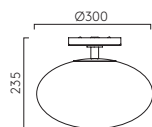

ZEPP0 CEILING

▼ LAMP EXCLUDED, SEE PAGE 685 / La lampe exclu, voir page 685 / La lampadina esclusi a pagina 685 / Das Leuchtmittel ist ausgeschlossen, sie auf Seite 685.



CASTIRO 225 (1291001)

PCh

CASTIRO 225

ZONES 2 3

	LAMP	WATT	CLASS		
PCh 1291001	E27 LED ▼	12W max		✓	✓

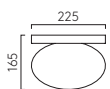

CASTIRO 225

▼ LAMP EXCLUDED, SEE PAGE 685 / La lampe exclu, voir page 685 / La lampadina esclusi a pagina 685 / Das Leuchtmittel ist ausgeschlossen, sie auf Seite 685.







LED

MASSA 300 LED (1337004)

MW

MASSA

		LAMP	WATT	INPUT	K	CRI	Lm	IP	CLASS	
300 LED	 1337004	Integral LED	16.4W	Mains 230V	2700	80	1311	44		-
350 LED	 1337002	Integral LED	24.5W	Mains 230V	3000	80	1367	44		✓

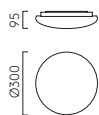

MASSA 300 LED

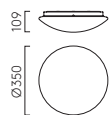

MASSA 350 LED





AREZZO CEILING (1049003)



AREZZO CEILING

	LAMP	WATT	CLASS		
PCh 1049003	E27 LED ▼	12W max		✓	✓

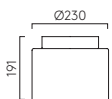

AREZZO CEILING

▼ LAMP EXCLUDED, SEE PAGE 685 / La lampe exclu, voir page 685 / La lampadina esclusi a pagina 685 / Das Leuchtmittel ist ausgeschlossen, sie auf Seite 685.





SYROS (1328001)

WG

SYROS

	LAMP	WATT	CLASS		
WG 1328001	E27 LED	12W max		✓	✓

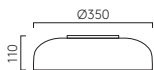

SYROS

▼ LAMP EXCLUDED, SEE PAGE 685 / La lampe exclu, voir page 685 / La lampadina esclusi a pagina 685 / Das Leuchtmittel ist ausgeschlossen, sie auf Seite 685.



PENDANTS

LAMPES SUSPENDUES • ANHÄNGER • LAMPADE A SOSPENSIONE

PENDANT



MARTINA THREE
P. 483



MARTINA FIVE
P. 483



RAFINA
P. 485



NEW
GINESTRA
P. 487



ATELIER PENDANT
P. 489



JOEL PENDANT
P. 491



HOMEFIELD
PENDANT
P. 493



ZEPO
PENDANT 300
P. 495



ZEPO
PENDANT 400
P. 495



NIMIS 350
P. 497



OSCA PENDANT
P. 499



OSCA PENDANT
P. 499



1



2



3



FABRIC PENDANTS

PENDANTS TISSU • HÄNGELEUCHTEN AUS STOFF • PENDENTI IN TESSUTO

1. TAPERED ROUND 400 PLEATED (5002009 + 1328001)
2. DRUM 500 (5016011 + 1328001)
3. DRUM 400 PLEATED (5016014 + 1328001)
4. DRUM 420 (5016006 + 1184005)
5. TAPERED ROUND 400 PLEATED (5002008 + 1184005)



PENDANT SHADES

NUANCES PENDENTIF • ANHÄNGER SCHATTIERUNGEN • PARALUMI PENDENT



∅:420

DRUM 420

- WF 5016004
- BF 5016005
- OF 5016006
- PF —



∅:500

DRUM 500

- WF 5016010
- BF 5016011
- OF 5016012
- PF —



∅:400

DRUM 400 PLEATED

- WF 5016013
- BF 5001003
- OF —
- PF 5016014



∅:500

DRUM 500 PLEATED

- WF 5016016
- BF 5016017
- OF —
- PF 5016018



∅:400

TAPERED ROUND 400 PLEATED

- WF 5002009
- BF —
- OF —
- PF 5002010

P. 687: SPECIAL SHADE COLOURS Couleurs spéciales / Sonderfarben / Colori speciali

COLOUR OPTIONS

OPTIONS DE COULEURS • FARBOPTIONEN • OPZIONI DI COLORE

*PLEASE NOTE COLOURS MAY VARY FROM BATCH TO BATCH
 Merci de noter que les couleurs peuvent varier d'un lot à l'autre
 Bitte beachten: Farben können je nach Charge variieren
 I colori potrebbero essere diversi a seconda del lotto di produzione.



WF

WF*
 White fabric
 Tissu blanc
 Weißer Stoff
 Tessuto bianco

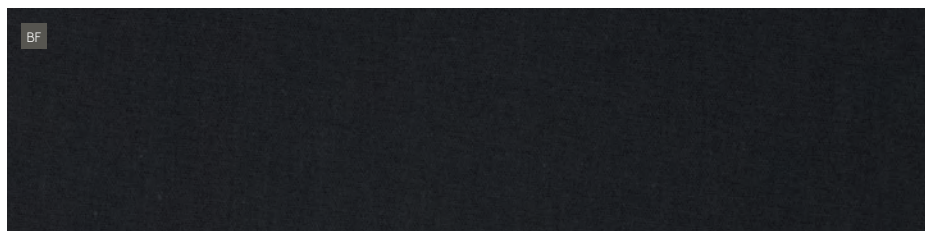

BF

BF*
 Black fabric
 Tissu noir
 Schwarzer Stoff
 Tessuto nero

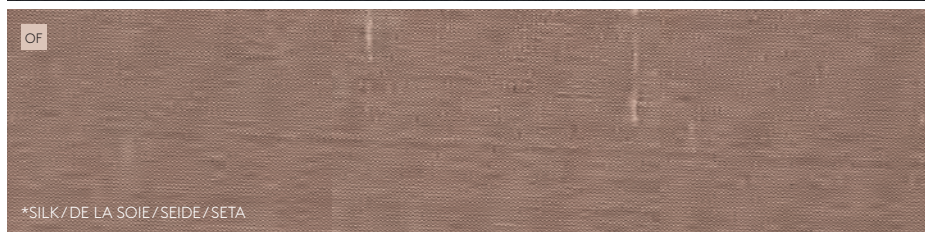

OF

OF*
 Oyster fabric
 Tissu oyster
 Oyster Stoff
 Tessuto madreperla (seta)

*SILK/DE LA SOIE/SEIDE/SETA

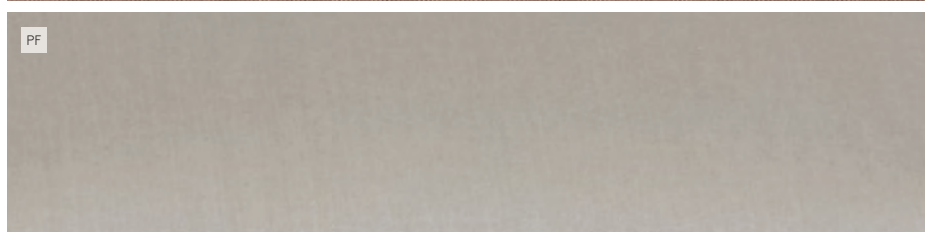

PF

PF*
 Putty fabric
 Tissu putty
 Putty Stoff
 Tessuto grigio stucco

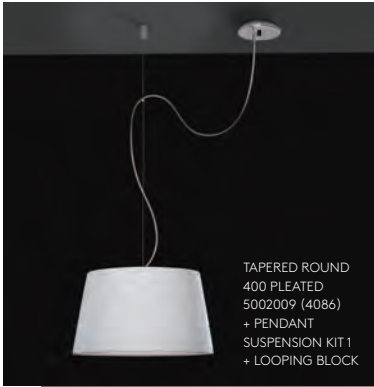

PENDANT SUSPENSION KIT 1 (1184004) + DRUM 420 SHADE (5016004)



6015001 Polished chrome
6015002 Matt Nickel

LOOPING BLOCK FOR
USE WITH / convient pour
/ zur verwendung mit / da
utilizzare con: Pendant
Suspension Kit 1, Zeppo
Pendant 300 & Nimis.



PENDANT SUSPENSION KIT 1

SHADE EXCLUDED

	LAMP	WATT	CLASS
PCh 1184004	E27 LED ▼	12W max	☐ ✓
MN 1184003			

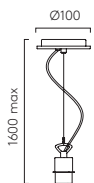

PENDANT SUSPENSION KIT 1

▼ LAMP EXCLUDED, SEE PAGE 685 / La lampe exclu,
voir page 685 / La lampadina esclusi a pagina 685 /
Das Leuchtmittel ist ausgeschlossen, sie auf Seite 685.



PENDANT SUSPENSION KIT 2 (1184006) + DRUM 500 PLEATED SHADE (5016018)



PENDANT SUSPENSION KIT 2

SHADE EXCLUDED

	LAMP	WATT	CLASS
MN 1184005	E27 LED	12W max	
MW 1184006			



PENDANT SUSPENSION KIT 2

▼ LAMP EXCLUDED, SEE PAGE 685 / La lampe exclu, voir page 685 / La lampadina esclusi a pagina 685 / Das Leuchtmittel ist ausgeschlossen, sie auf Seite 685.





MARTINA THREE (1302001 + 5006002)

MN

MARTINA

SHADE EXCLUDED

	LAMP	WATT	CLASS	
THREE MN 1302001	E14 LED ▼	3 x 7W max		✓
FIVE MN 1302002	E14 LED ▼	5 x 7W max		✓

 145 Ø:215 TAPERED ROUND 215	 135 Ø:177 TAPERED DRUM 177	 180 d:175 w:175 TAPERED SQUARE 175	 160 Ø:250 DRUM 250 Martina 3 only
WF 5006001 BF 5006002 OF 5006003 PF 5006004	WF 5013001 BF 5013002 OF 5013003 PF 5013006	WF 5005001 BF 5005002 OF 5005003 PF 5005004	WF 5016007 BF 5016008 OF 5016009 PF 5016019

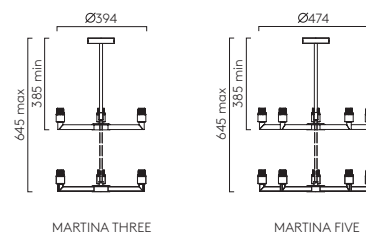

▼ LAMP EXCLUDED, SEE PAGE 685 / La lampe exclu, voir page 685 / La lampadina esclusi a pagina 685 / Das Leuchtmittel ist ausgeschlossen, sie auf Seite 685.

P. 687: SPECIAL COLOURS Couleurs spéciales / Sonderfarben / Colori speciali





RAFINA (1320001 + 5025001)



RAFINA

SHADE EXCLUDED

MN	Br	LAMP	WATT	CLASS	
1320001	1320002	E27 LED ▼	12W max	⊕	✓

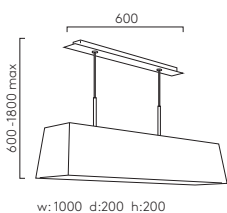

RAFINA SHADE

- WF 5025001
- BF 5025002
- OF 5025003
- PF —

P. 687: SPECIAL COLOURS Couleurs spéciales / Sonderfarben / Colori speciali

▼ LAMP EXCLUDED, SEE PAGE 685 / La lampe exclu, voir page 685 / La lampadina esclusi a pagina 685 / Das Leuchtmittel ist ausgeschlossen, sie auf Seite 685.





GINESTRA 500 (1361014)



GINESTRA 400 (1361004)



GINESTRA 300 (1361011)



GINESTRA

300	MB 1361001	LG 1361003	MW 1361011
400	MB 1361002	LG 1361004	MW 1361012
NEW 500	MB 1361014	LG 1361015	MW 1361013

LAMP	WATT	CLASS	
E27 LED▼	12W max		✓
E27 LED▼	12W max		✓
E27 LED▼	12W max		✓

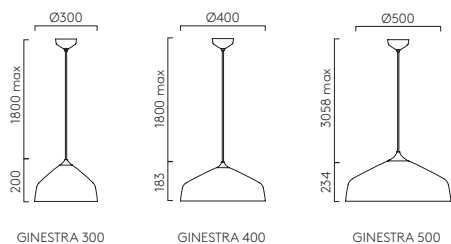

▼ LAMP EXCLUDED, SEE PAGE 685 / La lampe exclu, voir page 685 / La lampadina esclusi a pagina 685 / Das Leuchtmittel ist ausgeschlossen, sie auf Seite 685.





ATELIER PENDANT 150 (1224017)



ATELIER PENDANT 200 (1224022)



ATELIER PENDANT

	PA	MW	MB	LAMP	WATT	CLASS	
150	1224017	1224018	1224019	E27 LED ▼	12W max		✓
200	1224020	1224021	1224022	E27 LED ▼	12W max		✓

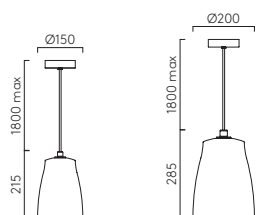

ATELIER PENDANT 150 ATELIER PENDANT 200

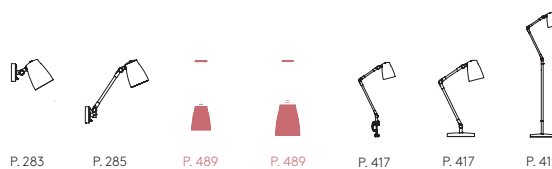

▼ LAMP EXCLUDED, SEE PAGE 685 / La lampe exclu, voir page 685 / La lampadina esclusi a pagina 685 / Das Leuchtmittel ist ausgeschlossen, sie auf Seite 685.





JOEL PENDANT 170 (1223018)



JOEL PENDANT 170 (1223017)



JOEL PENDANT 270 (1223024)



JOEL PENDANT

				LAMP	WATT	CLASS	
170	<input type="checkbox"/> PCh 1223019	<input type="checkbox"/> MB 1223018	<input type="checkbox"/> Cr 1223017	E27 LED ▼	12W max	<input type="checkbox"/>	✓
270	<input type="checkbox"/> PCh 1223024	<input type="checkbox"/> MB 1223023	<input type="checkbox"/> Cr 1223025	E27 LED ▼	12W max	<input type="checkbox"/>	✓

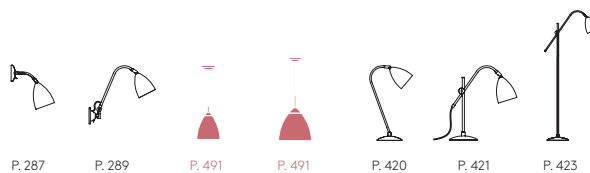
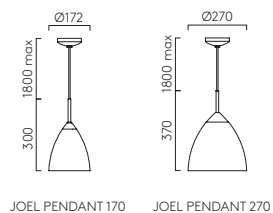

▼ LAMP EXCLUDED, SEE PAGE 685 / La lampe exclu, voir page 685 / La lampadina esclusi a pagina 685 / Das Leuchtmittel ist ausgeschlossen, sie auf Seite 685.





HOMEFIELD PENDANT 240 (1095019)



HOMEFIELD PENDANT 360 (1095015)



HOMEFIELD PENDANT

	TB	PN	LAMP	WATT	CLASS	☑	Ⓢ
240	1095010	1095019	E27 LED▼	12W max	□	✓	✓
360	1095015	1095020	E27 LED▼	12W max	□	✓	✓

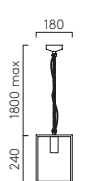

HOMEFIELD
PENDANT 240

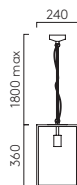

HOMEFIELD
PENDANT 360

▼ LAMP EXCLUDED, SEE PAGE 685 / La lampe exclu, voir page 685 / La lampadina esclusi a pagina 685 / Das Leuchtmittel ist ausgeschlossen, sie auf Seite 685.





ZEPP0 PENDANT 300 (1176002)

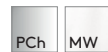

ZEPP0 PENDANT

		LAMP	WATT	CLASS		
300	1176002	E27 LED ▼	12W max		✓	✓
400	1176003	E27 LED ▼	12W max		✓	✓

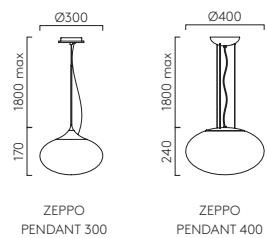

▼ LAMP EXCLUDED, SEE PAGE 685 / La lampe exclu, voir page 685 / La lampadina esclusi a pagina 685 / Das Leuchtmittel ist ausgeschlossen, sie auf Seite 685.





NIMIS 350 (1346001)

WG

NIMIS 350

	LAMP	WATT	CLASS		
WG 1346001	E27 LED ▼	12W max		✓	✓

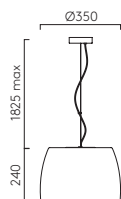

▼ LAMP EXCLUDED, SEE PAGE 685 / La lampe exclu, voir page 685 / La lampadina esclusi a pagina 685 / Das Leuchtmittel ist ausgeschlossen, sie auf Seite 685.





OSCA PENDANT ROUND 400 (1252014)



OSCA PENDANT SQUARE 400 (1252015)



OSCA PENDANT

		LAMP	WATT	CLASS
ROUND 400	1252014	GU10 LED▼	6W max	
SQUARE 400	1252015	GU10 LED▼	6W max	

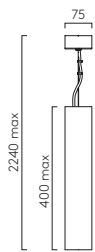

OSCA PENDANT
ROUND/SQUARE 400

▼ LAMP EXCLUDED, SEE PAGE 685 / La lampe exclu, voir page 685 / La lampadina esclusi a pagina 685 / Das Leuchtmittel ist ausgeschlossen, sie auf Seite 685.



DOWNLIGHTS

DOWNLIGHTS • EINBAUSTRAHLER • FARETTI DE INCASSO



● VOID
P. 503



● TRIMLESS ROUND
P. 505



● TRIMLESS SQUARE
P. 507



TRIMLESS TWIN
P. 507



BLANCO FIXED
P. 509



BLANCO FIXED TWIN
P. 509



BLANCO 45°
P. 511



BLANCO ADJ
P. 511



BLANCO ADJ TWIN
P. 511



● **NEW**
MINIMA ROUND
P. 513



● MINIMA SQUARE
P. 515



● **NEW**
MINIMA TWIN
P. 513



● APRILIA ROUND
P. 517



● APRILIA SQUARE
P. 517



● APRILIA TWIN
P. 517



TARO ROUND
P. 519



TARO SQUARE
P. 521



TARO TWIN
P. 521



TARO TRIPLE
P. 521



KOS ROUND
P. 523



KOS SQUARE
P. 523



● OSCA LED ROUND
P. 525



● OSCA LED SQUARE
P. 525



OSCA FIXED
P. 527



OSCA ADJ
P. 529



OSCA ADJ TWIN
P. 529

LED



THE VOID RANGE MUST
BE INSTALLED BEFORE
PLASTERING

La gamme Void doit être impérativement installée avant plafonnage. / Die Void Produktreihe muss vor dem Verputzen eingebaut werden. / La linea Void deve essere installata prima della posa del controsoffitto.



TO VIEW A 'HOW TO INSTALL' VIDEO,
PLEASE VISIT: ASTROLIGHTING.COM

La gamme Void doit être impérativement installée avant plafonnage. Pour visionner une "vidéo d'installation" veuillez visiter. / Die Void Produktreihe muss vor dem Verputzen eingebaut werden. Um ein Montagevideo anzusehen, besuchen Sie bitte. / La linea Void deve essere installata prima della posa del controsoffitto. Per visualizzare un video su 'come installare' visitate il nostro sito.

VOID



DOWNLIGHT

55

	LAMP	WATT	INPUT	K	CRI	Lm	IP	CLASS					
MW 1392004	Integral LED	6.8W	700mA▼	2700	80	501	65		Ø70	✓	25°	✓	✓
MW 1392001	Integral LED	6.8W	700mA▼	3000	80	525	65		Ø70	✓	25°	✓	✓
MW 1392017 MB 1392018	GU10 LED▼	6W max	-	-	-	-	65		Ø73	✓	-	✓	-

80

MW 1392002	Integral LED	9.1W	250mA▼	3000	80	877	65		Ø95	✓	25°	✓	✓
MW 1392005	Integral LED	9.1W	250mA▼	2700	80	863	65		Ø95	✓	14°	✓	✓
MW 1392006	Integral LED	9.1W	250mA▼	2700	93	690	65		Ø95	✓	14°	✓	✓
MW 1392007	Integral LED	9.1W	250mA▼	3000	80	888	65		Ø95	✓	14°	✓	✓
MW 1392008	Integral LED	9.1W	250mA▼	3000	93	667	65		Ø95	✓	14°	✓	✓
MW 1392009	Integral LED	9.1W	250mA▼	2700	93	611	65		Ø95	✓	25°	✓	✓
MW 1392010	Integral LED	9.1W	250mA▼	3000	93	653	65		Ø95	✓	25°	✓	✓
MW 1392012	Integral LED	9.1W	250mA▼	2700	80	840	65		Ø95	✓	25°	✓	✓
MW 1392019 MB 1392016	GU10 LED▼	6W max	-	-	-	-	65		Ø98	✓	-	✓	-

100

MW 1392003	Integral LED	12.7W	350mA▼	3000	80	1230	65		Ø117	✓	25°	✓	✓
MW 1392011	Integral LED	12.7W	350mA▼	2700	80	1219	65		Ø117	✓	25°	✓	✓

ACCESSORIES



55 BLACK BEZEL
1392013



80 BLACK BEZEL
1392014



100 BLACK BEZEL
1392015

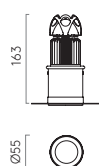

VOID 55 LED

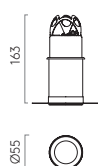

VOID 55 GU10

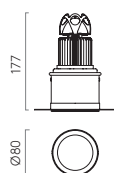

VOID 80 LED

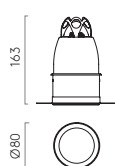

VOID 80 GU10

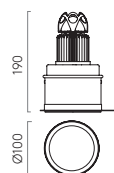

VOID 100 LED

🔥 Our fire rated downlights comply with all the latest building regulations: Part B - Fire Safety. The downlights have been tested to provide a minimum of 90 minutes fire protection (BS 476: part 21).

▼ LAMP OR DRIVER EXCLUDED, SEE PAGE 683. La lampe/ driver exclu, voir page 683. La lampadina/driver esclusi a pagina 683. Das Leuchtmittel/treiber ist ausgeschlossen, sie auf Seite 683.

LED

THE TRIMLESS RANGE MUST BE
INSTALLED BEFORE PLASTERING

La gamme Trimless doit être
imperativement installée avant plafonnage.
/Die Trimless Produktreihe muss vor dem
Verputzen eingebaut werden./La linea
Trimless deve essere installata prima della
posa del controsoffitto.

▶ TO VIEW A 'HOW TO INSTALL' VIDEO,
PLEASE VISIT: ASTROLIGHTING.COM

La gamme Trimless doit être imperativement
installée avant plafonnage. Pour visionner
une "vidéo d'installation" veuillez visiter. /Die
Trimless Produktreihe muss vor dem Verputzen
eingebaut werden. Um ein Montagevideo
anzusehen, besuchen Sie bitte. /La linea
Trimless deve essere installata prima della
posa del controsoffitto. Per visualizzare un
video su 'come installare' visitate il nostro sito.

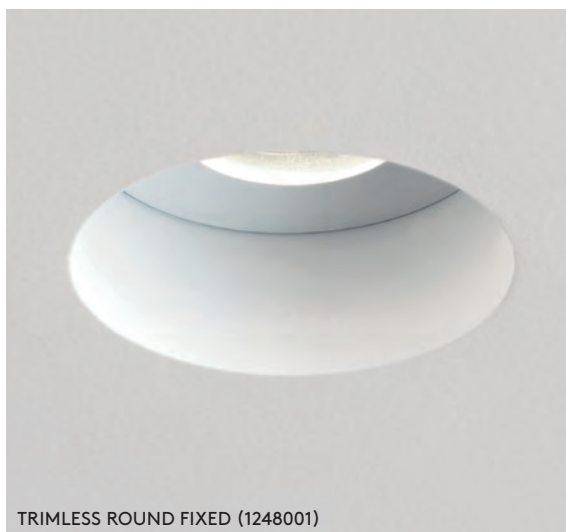

TRIMLESS ROUND FIXED (1248001)

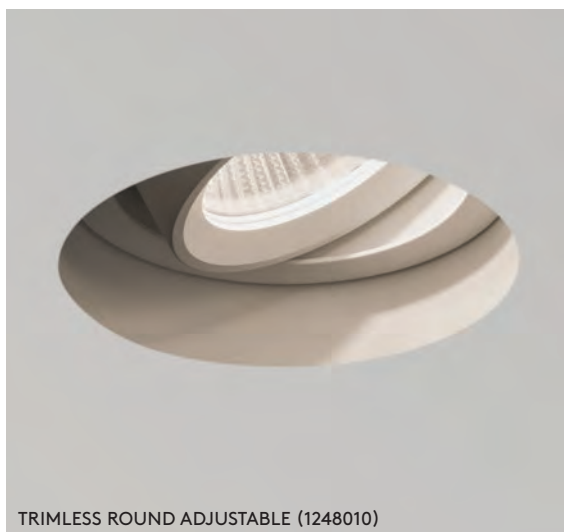

TRIMLESS ROUND ADJUSTABLE (1248010)



TRIMLESS

ROUND FIXED

	LAMP	WATT	INPUT	K	CRI	Lm	IP	CLASS	⚡	🕒	🔥	🌐
1248011	Integral LED	6.8W	700mA [▼]	2700	80	454	20	◆	Ø83	✓	✓	✓
1248001	GU5.3 LED [▼]	6W max	12V [▼]	-	-	-	65	◆	Ø86	✓	✓	✓
1248002	GU10 LED [▼]	6W max	-	-	-	-	65	□	Ø86	✓	✓	✓

ROUND ADJUSTABLE

1248010	Integral LED	10.2W	700mA [▼]	2700	80	528	20	◆	Ø79	✓	-	✓
1248006	GU10 LED [▼]	6W max	-	-	-	-	20	⊕	Ø111	✓	✓	-

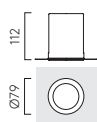

TRIMLESS ROUND
FIXED LED

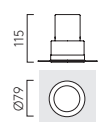

TRIMLESS ROUND
FIXED GU5.3/GU10



TRIMLESS ROUND
ADJUSTABLE LED

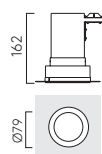

TRIMLESS ROUND
ADJUSTABLE GU10

⚡ Our fire rated downlights comply with all the latest building regulations: Part B - Fire Safety. The downlights have been tested to provide a minimum of 90 minutes fire protection (BS 476: part 21).

▼ LAMP OR DRIVER EXCLUDED, SEE PAGE 683. La lampe/driver exclu, voir page 683. La lampadina/driver esclusi a pagina 683. Das Leuchtmittel/treiber ist ausgeschlossen, sie auf Seite 683.





TRIMLESS TWIN ADJUSTABLE (1248008)



TRIMLESS SQUARE ADJUSTABLE (1248009)



TRIMLESS

SQUARE FIXED

	LAMP	WATT	INPUT	K	CRI	Lm	IP	CLASS	🔌	🕒	🔥	🌍
MW 1248005	GU10 LED▼	6W max	-	-	-	-	65	□	W:95 H:95	✓	✓	-
MW 1248012	Integral LED	6.8W	700mA▼	2700	80	475	20	◊	W:83 H:83	✓	✓	✓

SQUARE ADJUSTABLE

MW 1248007	GU10 LED▼	6W max	-	-	-	-	20	⊕	W:111 H:111	✓	✓	-
MW 1248009	Integral LED	9.2W	700mA▼	2700	80	544	20	◊	W:100 H:95	✓	-	✓

TWIN ADJUSTABLE

MW 1248008	GU10 LED▼	2 x 6W max	-	-	-	-	20	⊕	W:111 H:215	✓	✓	-
------------	-----------	------------	---	---	---	---	----	---	----------------	---	---	---

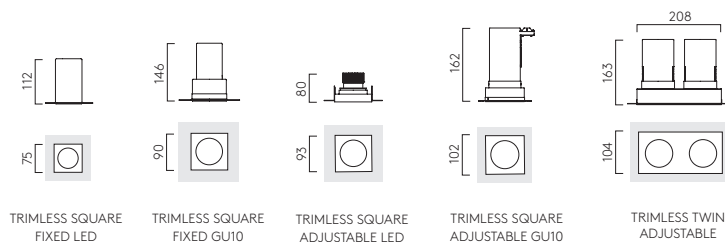

THE TRIMLESS RANGE MUST BE INSTALLED BEFORE PLASTERING

La gamme Trimless doit être impérativement installée avant plafonnage. /Die Trimless Produktreihe muss vor dem Verputzen eingebaut werden. /La linea Trimless deve essere installata prima della posa del controsoffitto.

▶ TO VIEW A 'HOW TO INSTALL' VIDEO, PLEASE VISIT: ASTROLIGHTING.COM

La gamme Trimless doit être impérativement installée avant plafonnage. Pour visionner une "vidéo d'installation" veuillez visiter. /Die Trimless Produktreihe muss vor dem Verputzen eingebaut werden. Um ein Montagevideo anzusehen, besuchen Sie bitte. /La linea Trimless deve essere installata prima della posa del controsoffitto. Per visualizzare un video su "come installare" visitate il nostro sito.

⚡ Our fire rated downlights comply with all the latest building regulations: Part B - Fire Safety. The downlights have been tested to provide a minimum of 90 minutes fire protection (BS 476: part 21).

▼ LAMP/OR DRIVER EXCLUDED, SEE PAGE 683. La lampe/driver exclu, voir page 683. La lampadina/driver esclusi a pagina 683. Das Leuchtmittel/treiber ist ausgeschlossen, sie auf Seite 683.





BLANCO ROUND FIXED (1253004)



BLANCO 45° (1253003)



BLANCO TWIN FIXED (1253001)



BLANCO

		LAMP	WATT	CLASS		
ROUND FIXED	1253004	GU10 LED▼	6W max		Ø131	✓
SQUARE FIXED	1253002	GU10 LED▼	6W max		W:120 H:120	✓
TWIN FIXED	1253001	GU10 LED▼	2 x 6W max		W:190 H:120	✓
45°	1253003	GU10 LED▼	6W max		W:126 H:125	✓

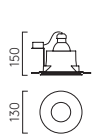

BLANCO ROUND

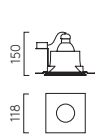

BLANCO SQUARE

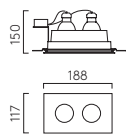

BLANCO TWIN

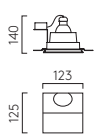

BLANCO 45°

THE BLANCO RANGE IS IDEALLY INSTALLED AFTER PLASTERING, REQUIRING ONLY MINIMAL FILLING AFTER INTALLATION. La gamme Blanco est idéalement installée après le plafonnage et requiert un minimum de finition. / Die Blanco Produktpalette sollte idealerweise nach dem Verputzen eingebaut werden, da sie nach der Installation nur eine minimale Auffüllung erfordern. / La linea Blanco può essere installata dopo la posa del controsoffitto, richiede solo una stuccatura finale.

▼ LAMP EXCLUDED, SEE PAGE 685 / La lampe exclu, voir page 685 / La lampadina esclusi a pagina 685 / Das Leuchtmittel ist ausgeschlossen, sie auf Seite 685.



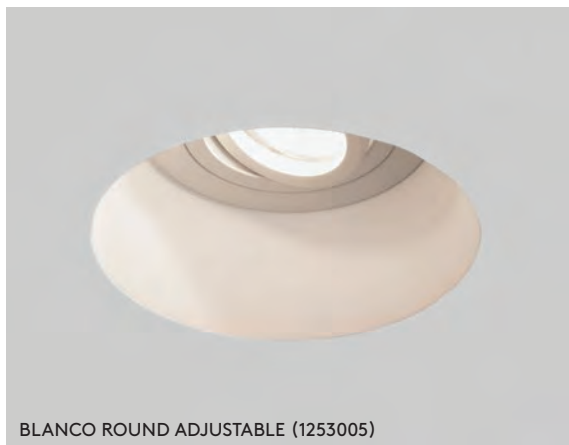

BLANCO ROUND ADJUSTABLE (1253005)



BLANCO SQUARE ADJUSTABLE (1253007)



BLANCO TWIN ADJUSTABLE (1253006)



BLANCO

		LAMP	WATT	CLASS		
ROUND ADJUSTABLE	1253005	GU10 LED ▼	6W max		Ø152	✓
SQUARE ADJUSTABLE	1253007	GU10 LED ▼	6W max		W:150 H:150	✓
TWIN ADJUSTABLE	1253006	GU10 LED ▼	2 x 6W max		W:230 H:150	✓

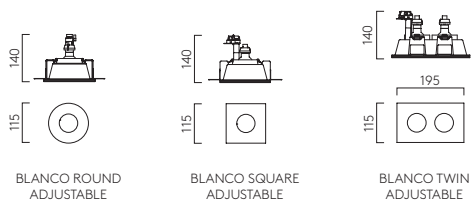

THE BLANCO RANGE IS IDEALLY INSTALLED AFTER PLASTERING, REQUIRING ONLY MINIMAL FILLING AFTER INSTALLATION.
 La gamme Blanco est idéalement installée après le plafonnage et requiert un minimum de finition. / Die Blanco Produktpalette sollte idealerweise nach dem Verputzen eingebaut werden, da sie nach der Installation nur eine minimale Auffüllung erfordern. / La linea Blanco può essere installata dopo la posa del controsoffitto, richiede solo una stuccatura finale.

▼ LAMP EXCLUDED, SEE PAGE 685 / La lampe exclu, voir page 685 / La lampadina esclusi a pagina 685 / Das Leuchtmittel ist ausgeschlossen, sie auf Seite 685.

LED



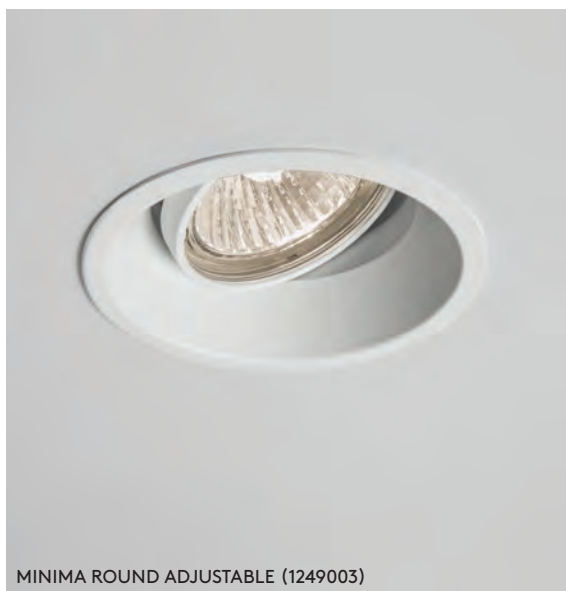

MINIMA ROUND

FIXED		LAMP	WATT	INPUT	K	CRI	Lm	IP	CLASS	☰	☹	🔥	🌐
TW 1249005		Integral LED	10.7W	700mA▼	2700	80	434	20	⏏	Ø76	✓	-	✓
MW 1249002	MB 1249015	GU10 LED▼	6W max	-	-	-	-	20	⏏	Ø76	✓	-	-
MW 1249010		GU10 LED▼	6W max	-	-	-	-	20	⏏	Ø92	✓	✓	-
ADJUSTABLE													
MW 1249003	MB 1249016	GU10 LED▼	6W max	-	-	-	-	20	⏏	Ø76	✓	-	-
MW 1249008		GU10 LED▼	6W max	-	-	-	-	20	⏏	Ø92	✓	✓	-
NEW TWIN ADJUSTABLE													
MW 1249028	MB 1249029	GU10 LED▼	6W max	-	-	-	-	20	⏏	Ø92	✓	✓	-
NEW 25°													
MW 1249025	MB 1249026	GU10 LED▼	6W max	-	-	-	-	20	⏏	Ø111	✓	-	-

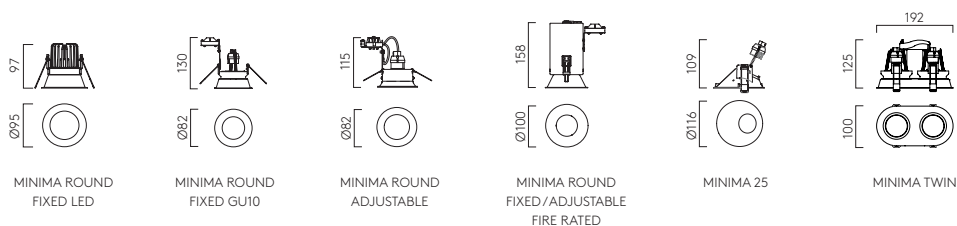

☰ Our fire rated downlights comply with all the latest building regulations: Part B - Fire Safety. The downlights have been tested to provide a minimum of 90 minutes fire protection (BS 476: part 21).

▼ LAMP / OR DRIVER EXCLUDED, SEE PAGE 683. La lampe / driver exclu, voir page 683. La lampadina / driver esclusi a pagina 683. Das Leuchtmittel / treiber ist ausgeschlossen, sie auf Seite 683.





MINIMA SQUARE FIXED (1249007)

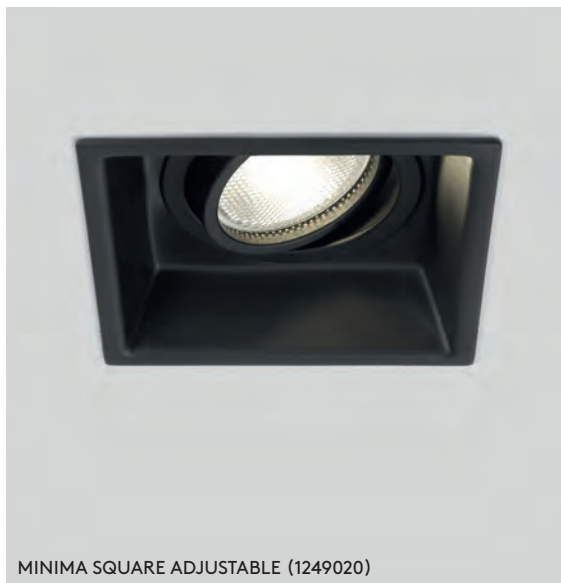

MINIMA SQUARE ADJUSTABLE (1249020)



MINIMA SQUARE

FIXED		LAMP	WATT	CLASS	☎	🔥
MW 1249007	MB 1249019	GU10 LED▼	6W max	⊕	W:92 L:92	✓ -
MW 1249011		GU10 LED▼	6W max	⊕	W:92 L:92	✓ ✓
ADJUSTABLE		LAMP	WATT	CLASS	☎	🔥
MW 1249006	MB 1249020	GU10 LED▼	6W max	⊕	W:92 L:92	✓ -
MW 1249009		GU10 LED▼	6W max	⊕	W:92 L:92	✓ ✓

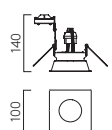

MINIMA SQUARE
FIXED/ADJUSTABLE

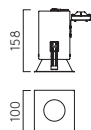

MINIMA SQUARE
FIXED/ADJUSTABLE
FIRE RATED

◆ Our fire rated downlights comply with all the latest building regulations: Part B - Fire Safety. The downlights have been tested to provide a minimum of 90 minutes fire protection (BS 476: part 21).

▼ LAMP EXCLUDED, SEE PAGE 685 / La lampe exclu, voir page 685 / La lampadina esclusi a pagina 685 / Das Leuchtmittel ist ausgeschlossen, sie auf Seite 685.





APRILIA ROUND (1256013)

APRILIA SQUARE (1256027)

APRILIA TWIN (1256019)



APRILIA

ROUND		LAMP	WATT	INPUT	K	CRI	Lm	CLASS	⌵	🔌	🔥	🌐
MW 1256020	AA 1256029	Integral LED	6.1W	350mA▼	3000	80	628	⬇️	Ø86	✓	-	✓
MW 1256024	AA 1256025	Integral LED	6.1W	350mA▼	2700	80	605	⬇️	Ø86	✓	-	✓
MW 1256013		Integral LED	6.1W	350mA▼	2700	80	605	⬇️	Ø92	✓	✓	✓
SQUARE												
MW 1256021	AA 1256030	Integral LED	6.1W	350mA▼	3000	80	628	⬇️	Ø86	✓	-	✓
MW 1256026	AA 1256027	Integral LED	6.1W	350mA▼	2700	80	605	⬇️	Ø86	✓	-	✓
MW 1256014		Integral LED	6.1W	350mA▼	2700	80	605	⬇️	Ø92	✓	✓	✓
TWIN												
MW 1256019	AA 1256028	Integral LED	2 x 6.1W	350mA▼	3000	80	1206	⬇️	W:165 L:85	✓	-	✓
MW 1256022	AA 1256023	Integral LED	2 x 6.1W	350mA▼	2700	80	1123	⬇️	W:165 L:85	✓	-	✓

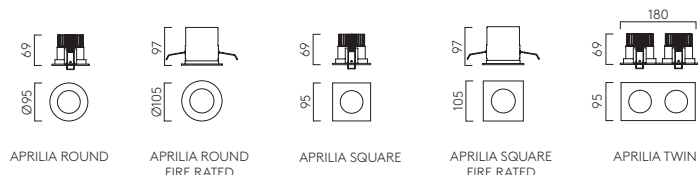

◆ Our fire rated downlights comply with all the latest building regulations: Part B - Fire Safety. The downlights have been tested to provide a minimum of 90 minutes fire protection (BS 476: part 21).

▼ DRIVER EXCLUDED, SEE PAGE 683 / Driver d'entrée exclu, voir page 683 / Driver esclusi a pagina 683 / Das treiber ist ausgeschlossen / Sie auf Seite 683.





TARO ROUND ADJUSTABLE (1240015)



TARO ROUND FIXED (1240013)



TARO ROUND

FIXED		LAMP	WATT	IP	CLASS			
MW 1240013	BA 1240011	GU10 LED ▼	6W max	20		Ø79	✓	-
MW 1240024		GU10 LED ▼	6W max	20		Ø86	✓	✓
ADJUSTABLE		LAMP	WATT	IP	CLASS			
MW 1240015		GU10 LED ▼	6W max	20		Ø79	✓	-
MW 1240028	BA 1240027	GU10 LED ▼	6W max	20		Ø86	✓	✓

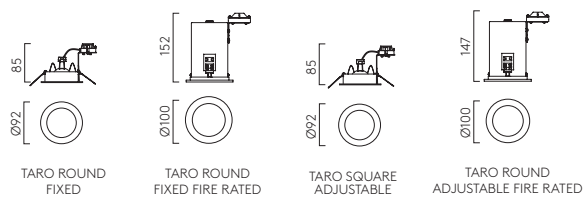

♦ Our fire rated downlights comply with all the latest building regulations: Part B - Fire Safety. The downlights have been tested to provide a minimum of 90 minutes fire protection (BS 476: part 21).

▼ LAMP EXCLUDED, SEE PAGE 685 / La lampe exclu, voir page 685 / La lampadina esclusi a pagina 685 / Das Leuchtmittel ist ausgeschlossen, sie auf Seite 685.





TARO SQUARE FIXED (1240014)



TARO TWIN ADJUSTABLE (1240017)



TARO SQUARE

FIXED		LAMP	WATT	IP	CLASS			
1240014		GU10 LED ▼	6W max	20		Ø79	✓	-
1240026		GU10 LED ▼	6W max	20		Ø86	✓	✓
ADJUSTABLE								
1240016	1240012	GU10 LED ▼	6W max	20		Ø79	✓	-
1240030	1240029	GU10 LED ▼	6W max	20		Ø86	✓	✓
TWIN ADJUSTABLE								
1240017	1240018	GU10 LED ▼	2 x 6W max	20		W:80 L:160	✓	-
1240032	1240031	GU10 LED ▼	2 x 6W max	20		W:97 L:185	✓	✓
TRIPLE ADJUSTABLE								
1240019		GU10 LED ▼	3 x 6W max	20		W:80 L:235	✓	-

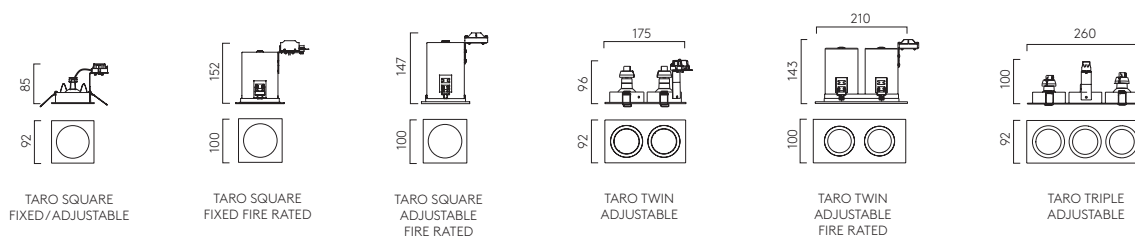

⬆ Our fire rated downlights comply with all the latest building regulations: Part B - Fire Safety. The downlights have been tested to provide a minimum of 90 minutes fire protection (BS 476: part 21).

▼ LAMP EXCLUDED, SEE PAGE 685 / La lampe exclu, voir page 685 / La lampadina esclusi a pagina 685 / Das Leuchtmittel ist ausgeschlossen, sie auf Seite 685.





KOS ROUND (1326003)



KOS SQUARE (1326008)



KOS

					LAMP	WATT	IP	CLASS	🔄	🔌
ROUND	PCh 1326001	MW 1326002	TPS 1326003	TB 1326004	GU10 LED▼	6W max	65	☐	✓	✓
SQUARE	PCh 1326005	MW 1326008	TPS 1326006	TB 1326007	GU10 LED▼	6W max	65	☐	✓	✓

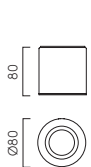

KOS ROUND
80

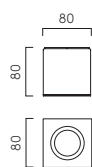

KOS SQUARE
80

▼ LAMP EXCLUDED, SEE PAGE 685 / La lampe exclu, voir page 685 / La lampadina esclusi a pagina 685 / Das Leuchtmittel ist ausgeschlossen, sie auf Seite 685.

LED





OSCA LED ROUND (1252022)



OSCA LED SQUARE (1252024)



OSCA LED

			LAMP	WATT	INPUT	K	CRI	Lm	IP	CLASS	
ROUND	1252022	1252023	Integral LED	7.7W	Mains 230V	2700	80	528	20		Phase
SQUARE	1252024	1252025	Integral LED	7.8W	Mains 230V	2700	80	507	20		Phase



ROUND LED



SQUARE LED





OSCA 140 SQUARE (1252004)



OSCA 200 ROUND (1252011)



OSCA FIXED

		LAMP	WATT	CLASS	
140 ROUND	1252003	GU10 LED▼	6W max		✓
140 SQUARE	1252004	GU10 LED▼	6W max		✓
200 ROUND	1252011	E27 LED▼	12W max		✓

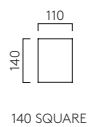
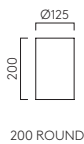
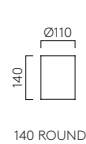

▼ LAMP EXCLUDED, SEE PAGE 685 / La lampe exclu, voir page 685 / La lampadina esclusi a pagina 685 / Das Leuchtmittel ist ausgeschlossen, sie auf Seite 685.





OSCA ADJUSTABLE

		LAMP	WATT	CLASS	
140 ROUND	1252006	GU10 LED ▼	6W max		✓
140 SQUARE	1252007	GU10 LED ▼	6W max		✓
140 TWIN	1252005	GU10 LED ▼	6W max		✓

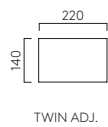
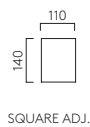
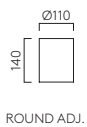

▼ LAMP EXCLUDED, SEE PAGE 685 / La lampe exclu, voir page 685 / La lampadina esclusi a pagina 685 / Das Leuchtmittel ist ausgeschlossen, sie auf Seite 685.



SPOTLIGHTS

SPOT • SPOTLIGHT • RIFLETTORI ORIENTABILI



NEW
CAN TRACK SPOT
P. 533



ASCOLI TRACK SPOT
P. 533



CAN SINGLE
P. 535



NEW
CAN RECESSED
P. 535



CAN TRIPLE ROUND
P. 535



CAN TRIPLE BAR
P. 535



NEW
CAN FOUR BAR
P. 535



ASCOLI SINGLE
P. 537



ASCOLI RECESSED
P. 537



ASCOLI SINGLE
SWITCHED
P. 537



ASCOLI TWIN
P. 537



ASCOLI TRIPLE
ROUND
P. 537



ASCOLI TRIPLE BAR
P. 537



ASCOLI FOUR BAR
P. 537



NEW
ASCOLI FIVE BAR
P. 537



POLAR SINGLE
P. 539



POLAR TRIPLE
P. 539



POLAR TRIPLE BAR
P. 539

LED





CAN 50 SPOT (1396001) + CAN 75 SPOT (1396003) + ASCOLI TRACK SPOT (1286033)



TRACK SPOTLIGHTS

			LAMP	WATT	INPUT	K	CRI	Lm	CLASS	
CAN 50 SPOT	1396001	1396002	Integral LED	7.7W	Mains 230V	3000	80	502		
CAN 75 SPOT	1396003	1396004	Integral LED	11.8W	Mains 230V	3000	80	986		
NEW CAN 100 SPOT	1396014	1396015	Integral LED	30.2W	Mains 230V	3000	80	1678		
ASCOLI TRACK SPOT	1286033	1286052	GU10 LED ▼	6W max	-	-	-	-		

TRACK ACCESSORIES

1M TRACK	6020001	6020009
2M TRACK	6020002	6020010
END CAP	6020003	6020011
END TO END CONNECTOR	6020004	6020012
LIVE END	6020005	6020013
LEFT CONNECTOR	6020006	6020014
RIGHT CONNECTOR	6020007	6020015
CENTRAL LIVE CONNECTOR	6020017	6020018
X CONNECTOR	6020019	6020020
T CONNECTOR LEFT FAR SIDE EARTH	6020027	6020028
T CONNECTOR LEFT NEAR SIDE EARTH	6020025	6020026
T CONNECTOR RIGHT FAR SIDE EARTH	6020023	6020024
T CONNECTOR RIGHT NEAR SIDE EARTH	6020021	6020022

ACCESSORIES

FOR USE WITH CAN TRACK SPOTS ONLY



CAN 50 BEZEL
6020008



CAN 75 BEZEL
6020016



CAN 100 BEZEL
6020029

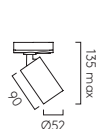

CAN 50 TRACK SPOT

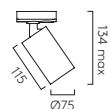

CAN 75 TRACK SPOT

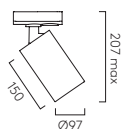

CAN 100 TRACK SPOT

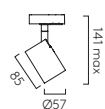

ASCOLI TRACK SPOT

PLEASE VISIT THE TOOLS SECTION OF OUR WEBSITE TO USE THE TRACK CONFIGURATOR / Veuillez consulter la section outils de notre site Web pour utiliser le configurateur de rail. / Visitate la sezione accessori del nostro sito per accedere al Configuratore di binary. / Bitte besuchen Sie den Tools-Bereich unserer Website, um den Track-Konfigurator zu verwenden.

INCLUDES REMOVEABLE GLARE GUARD FOR USE WITH CAN TRACK SPOTS ONLY

▼ LAMP EXCLUDED, SEE PAGE 685 / La lampe exclu, voir page 685 / La lampadina esclusi a pagina 685 / Das Leuchtmittel ist ausgeschlossen, sie auf Seite 685.

LED



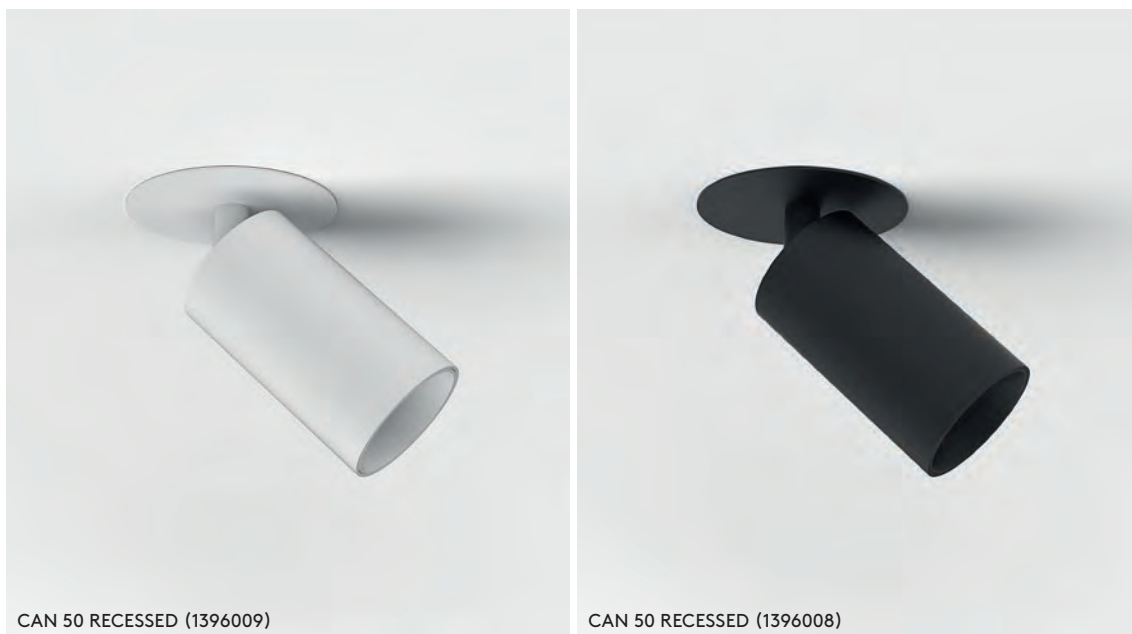

CAN

			LAMP	WATT	INPUT	K	CRI	Lm	CLASS	🔌
	50 SINGLE	1396005	Integral LED	7.7W	Mains 230V	3000	80	502	🔌	✓
	50 TRIPLE ROUND	1396006	Integral LED	22.6W	Mains 230V	3000	80	1435	🔌	✓
	50 TRIPLE BAR	1396007	Integral LED	22.6W	Mains 230V	3000	80	1435	🔌	✓
	50 FOUR BAR	1396013	Integral LED	30.3W	Mains 230V	3000	80	1960	🔌	✓
	50 RECESSED	1396009 1396008	Integral LED	7.7W	Mains 230V	3000	80	502	🔌	✓
	75 RECESSED	1396010 1396011	Integral LED	12.6W	Mains 230V	3000	80	986	🔌	✓

ACCESSORIES



CAN 50 BEZEL
6020008



CAN 75 BEZEL
6020016



CAN 50 SINGLE



CAN 50 RECESSED



CAN 75 RECESSED

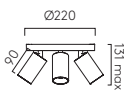

CAN 50 TRIPLE ROUND

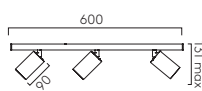

CAN 50 TRIPLE BAR

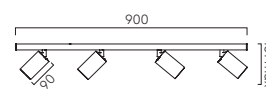

CAN 50 FOUR BAR

INCLUDES REMOVEABLE GLARE GUARD





ASCOLI SINGLE (1286001)



ASCOLI TWIN (1286036)



ASCOLI RECESSED (1286023)



ASCOLI FOUR BAR (1286008)

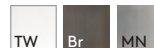

ASCOLI

				LAMP	WATT	CLASS		
SINGLE	1286001	1286004	1286015	GU10 LED▼	6W max		✓	-
RECESSED	1286021	1286022	1286023	GU10 LED▼	6W max		✓	-
SINGLE SWITCHED	1286010	1286009	1286011	GU10 LED▼	6W max		-	✓
TWIN	1286034	1286035	1286036	GU10 LED▼	2 x 6W max		✓	-
TRIPLE ROUND	1286002	1286005	1286012	GU10 LED▼	3 x 6W max		✓	-
TRIPLE BAR	1286003	1286006	1286013	GU10 LED▼	3 x 6W max		✓	-
FOUR BAR	1286007	1286008	1286014	GU10 LED▼	4 x 6W max		✓	-
NEW FIVE BAR	1286059	1286060	1286061	GU10 LED▼	5 x 6W max		✓	-

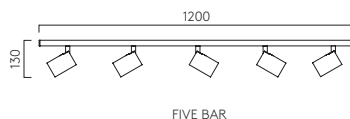
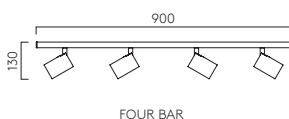
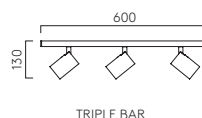
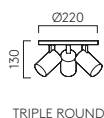
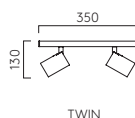
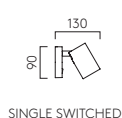
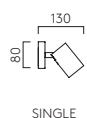

▼ LAMP EXCLUDED, SEE PAGE 685 / La lampe exclu, voir page 685 / La lampadina esclusi a pagina 685 / Das Leuchtmittel ist ausgeschlossen, sie auf Seite 685.





POLAR TRIPLE (1258002)



POLAR SINGLE (1258001)



POLAR

		LAMP	WATT	CLASS	
SINGLE	1258001	GU10 LED ▼	6W max		✓
TRIPLE	1258002	GU10 LED ▼	3 x 6W max		✓
TRIPLE BAR	1258003	GU10 LED ▼	3 x 6W max		✓



POLAR SINGLE

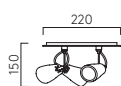

POLAR TRIPLE

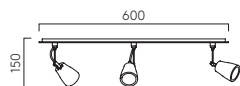

POLAR TRIPLE BAR

▼ LAMP EXCLUDED, SEE PAGE 685 / La lampe exclu, voir page 685 / La lampadina esclusi a pagina 685 / Das Leuchtmittel ist ausgeschlossen, sie auf Seite 685.